

CATALOGUE

2024

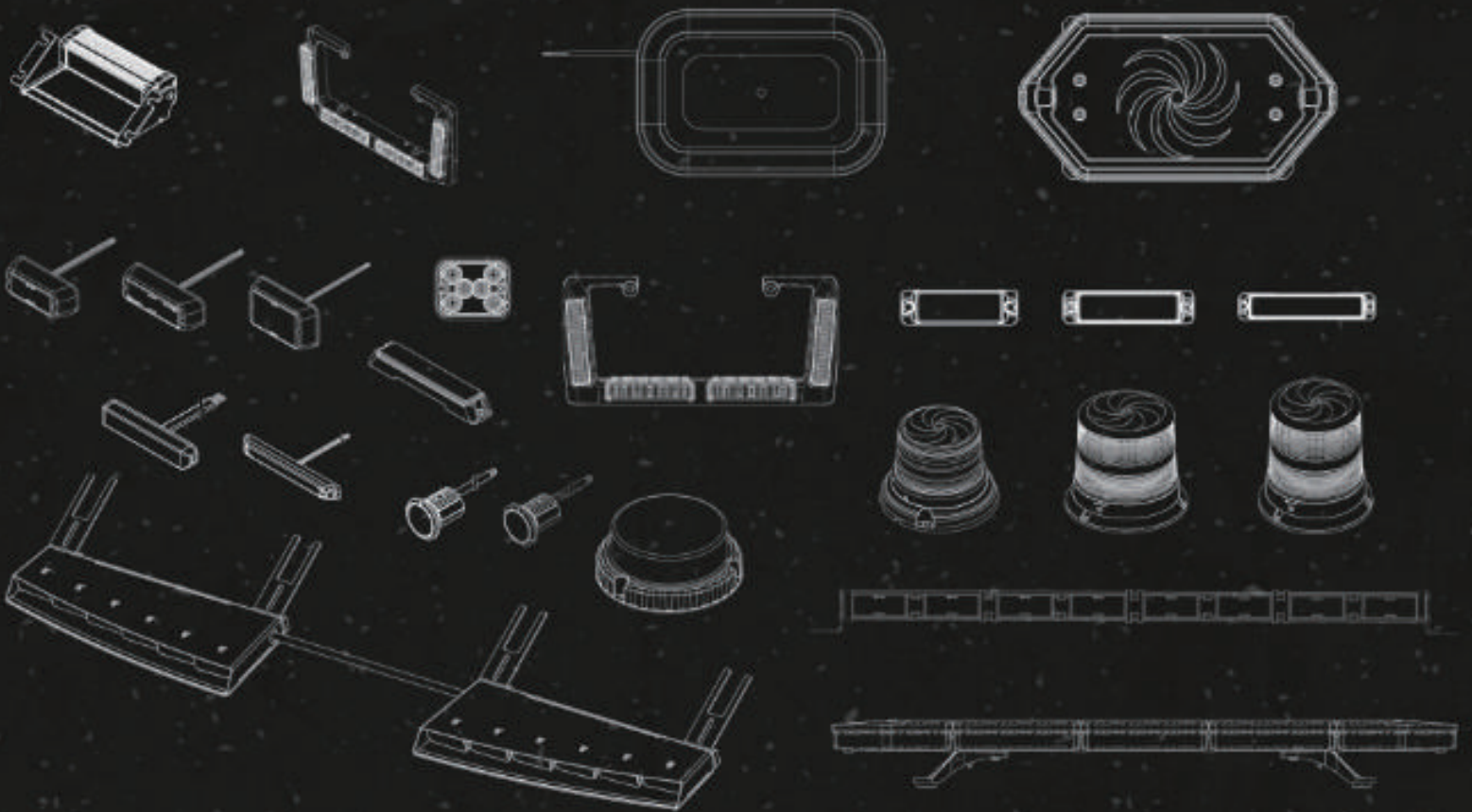

LN4 Mini Sniper Series

FEATURE

- TIR and Linear Optics
- Ingress Protection Rating: IP67 / IP69K
- Available in Single and Dual
- Input Voltage: 10~30VDC
- Input Current: 0.7A max@DC12V, 0.4A max@DC24V
- Flash Pattern : 19
- Ambient Temperature Range: -30~70°C
- Accessories: Screws*2
- Mounting Option: Surface mount and Bracket mount
- Synchronizable up to 8 lights



LN4F-61-B00



LN4L-C1-B/A

DIMENSIONS

L3.55"x W0.66" x D0.52" (90.2 x 16.7 x 13.3 mm)

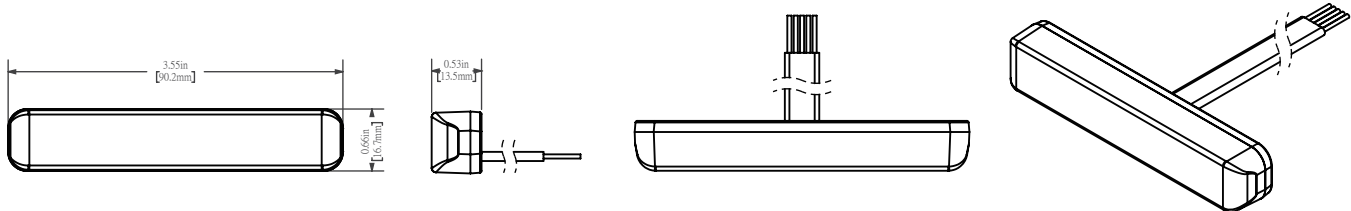

Model	LED Color	Compliance	Optics	LED
LN4F-61-R00	●	SAE J595, CA T13	Focus	6
LN4F-61-B00	●	SAE J595, CA T13, ECE R65 Class2	Focus	6
LN4F-61-A00	●	SAE J595, CA T13, ECE R65 Class2	Focus	6
LN4F-61-C00	●	SAE J595, CA T13	Focus	6
LN4L-C1-R/A	●	SAE J595	Linear	12
LN4L-C1-R/B	●	SAE J595	Linear	12
LN4L-C1-R/C	●	SAE J595	Linear	12
LN4L-C1-B/A	●	SAE J595, ECE R65 Class2	Linear	12
LN4L-C1-B/C	●	SAE J595	Linear	12
LN4L-C1-A/C	●	SAE J595	Linear	12

LN6 Sniper Series

FEATURE

- Linear Optics
- Ingress Protection Rating: IP67 / IP69K
- Available in Single, Dual and QUAD
- Input Voltage: 10~30VDC
- Input Current:
 - Single & Dual: 1.5A max @ DC12V, 1A max @ DC24V
 - QUAD: 0.8A max
- Flash Pattern : 33 (Single), 69 (Dual), 22 (QUAD)
- Ambient Temperature Range : -40~70°C
- Accessories: 1 Foam, Screws & Brackets
- Mounting Option : Surface mount/ Bracket mount/ Stud mount
- Synchronizable up to 8 lights



LN6L-61-A00



LN6L-C1-B/C



LN6L-G1-Q01

DIMENSIONS

L5.35" x W0.62" x D0.63" (136x 15.8 x 16 mm)

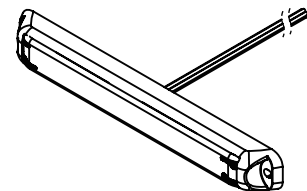
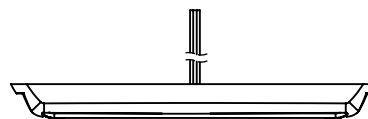
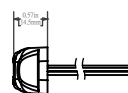

OPTIONAL ACCESSORIES: Shroud













Model	Option Description
R21-SHX-03	35° Dash Mount For Front Windshield
R21-SHX-04	85° Adhesive Mount For Quarter Window



R21-SHX-03



R21-SHX-04

Model	LED Color	Compliance	Optics	LED
LN6L-61-R00		SAE J595, CA T13,ECE R10	Linear	6
LN6L-61-B00		SAE J595, CA T13,ECE R10, ECE R65 Class2	Linear	6
LN6L-61-A00		SAE J595, CA T13,ECE R10, ECE R65 Class2	Linear	6
LN6L-61-C00		SAE J595, CA T13,ECE R10	Linear	6
LN6L-6A-B00		SAE J595, CA T13,ECE R10, ECE R65 Class2	Linear	6
LN6L-6A-A00		SAE J595, CA T13,ECE R10, ECE R65 Class2	Linear	6
LN6L-C1-R/A		SAE J595, CA T13,ECE R10	Linear	12
LN6L-C1-R/B		SAE J595, CA T13,ECE R10	Linear	12
LN6L-C1-R/C		SAE J595, CA T13,ECE R10	Linear	12
LN6L-C1-B/A		SAE J595, CA T13,ECE R10, ECE R65 Class1	Linear	12
LN6L-C1-B/C		SAE J595, CA T13,ECE R10	Linear	12
LN6L-C1-A/C		SAE J595, CA T13,ECE R10	Linear	12
LN6L-G1-Q01		SAE J595, CA T13,ECE R10	Linear	16

LM3 Mini Lighthead Series

FEATURE

- Ingress Protection Rating: IP67
- Available in Single
- Input Voltage: 10~30VDC
- Input Current: 0.6A max@DC12V, 0.35A max@DC24V
- Flash Pattern: 20
- Ambient Temperature Range: -30~50°C
- Housing: Aluminum
- Accessories: EVA Gasket*1, Screws *2
- Mounting Options: Surface mount / Bracket mount
- Synchronizable up to 8 lights



DIMENSIONS

L3.23" x W0.69" x D0.97" (82.1x17.5 x 24.7 mm)

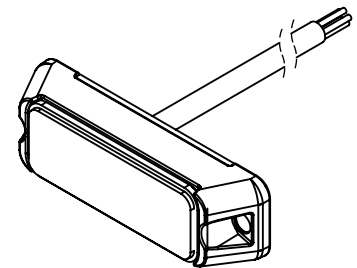
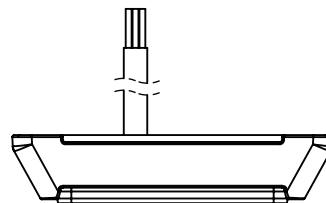
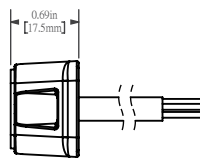
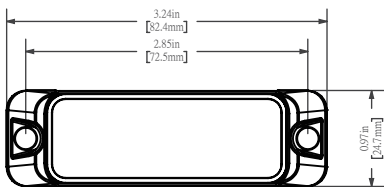

OPTIONAL ACCESSORIES:

Model	Option Description
R02-LM-01	L Bracket Screw Kits
R02-LM-02	C Bracket Screw Kits

Model	Option Description
R02-LM-06	L Bracket
R05-LM-01	LM3 Rubber Grommet



R02-LM-01







R02-LM-02



R02-LM-06

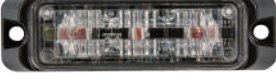

R05-LM-01

Optics	Model	LED Color	Compliance	LED
	*LM3F-31-R00	●	SAE J595, ECE R10	3
	*LM3F-31-B00	●	SAE J595, ECE R10	3
	*LM3F-31-A00	●	SAE J595, ECE R10	3
	LM3F-31-C00	●	SAE J595, ECE R10	3
	*LM3F-31-G00	●	SAE J595, ECE R10	3
	*LM3F-31-M00	●	SAE J595, ECE R10	3
	LM3E-31-R00	●	SAE J595, ECE R10	3
	LM3E-31-B00	●	SAE J595, ECE R10, ECE R65 Class 1	3
	LM3E-31-A00	●	SAE J595, ECE R10, ECE R65 Class 1	3
	LM3E-31-C00	●	SAE J595, ECE R10	3
	LM3E-31-G00	●	SAE J595, ECE R10	3
	LM3E-31-M00	●	SAE J595, ECE R10	3
	LM3C-31-R00	●	SAE J595, ECE R10	3
	LM3C-31-B00	●	SAE J595, ECE R10	3
	LM3C-31-A00	●	SAE J595, ECE R10	3
	LM3C-31-C00	●	SAE J595, ECE R10	3
	LM3C-31-G00	●	SAE J595, ECE R10	3
	LM3C-31-M00	●	SAE J595, ECE R10	3
	LM3L-31-R00	●	SAE J595, ECE R10	3
	LM3L-31-B00	●	SAE J595, ECE R10	3
	LM3L-31-A00	●	SAE J595, ECE R10	3
	LM3L-31-C00	●	SAE J595, ECE R10	3
	*LM3L-31-G00	●	SAE J595, ECE R10	3
	*LM3L-31-M00	●	SAE J595, ECE R10	3
	*LM3S-31-R00	●	SAE J595, ECE R10	3
	*LM3S-31-B00	●	SAE J595, ECE R10	3
	*LM3S-31-A00	●	SAE J595, ECE R10	3
	*LM3S-31-C00	●	SAE J595, ECE R10	3
	*LM3S-31-G00	●	SAE J595, ECE R10	3
	*LM3S-31-M00	●	SAE J595, ECE R10	3
	LM3R-31-R00	●	SAE J595, ECE R10	3
	LM3R-31-B00	●	SAE J595, ECE R10	3
	LM3R-31-A00	●	SAE J595, ECE R10	3
	LM3R-31-C00	●	SAE J595, ECE R10	3
	LM3R-31-G00	●	SAE J595, ECE R10	3
	LM3R-31-M00	●	SAE J595, ECE R10	3

*Production is contingent upon reaching a specified order quantity.

LM4 Mini Lighthead Series

FEATURE

- Ingress Protection Rating: IP67
- Available in Single, Dual, Split and QUAD
- Input Voltage: 10~30VDC
- Input Current: 1.0A max@DC12V, 0.6A max@DC24V
- Flash Pattern: 30 (Single), 50 (Dual), 24 (QUAD)
- Ambient Temperature Range: -30~50°C
- Housing: Aluminum
- Accessories: EVA Gasket*1, Screws *2
- Mounting Options: Surface mount / Bracket mount
- Synchronizable up to 8 lights



LM4C-41-B00



LM4L-C1-Q01

DIMENSIONS

L3.87" x W0.69" x D0.97" (98.2 x 17.5 x 24.7 mm)

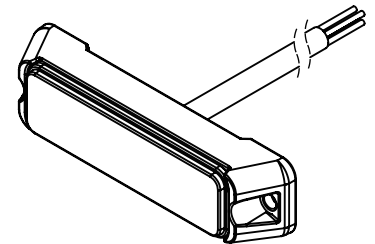
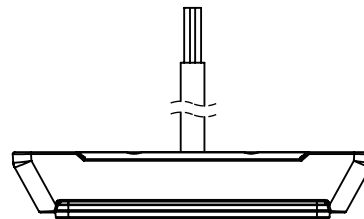
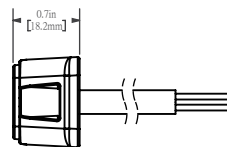
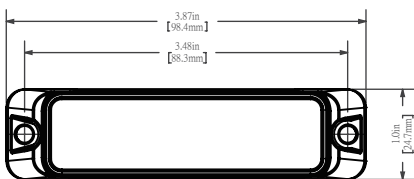

OPTIONAL ACCESSORIES:

Model	Option Description
R02-LM-01	L Bracket Screw Kits
R02-LM-02	C Bracket Screw Kits
R02-LM-05	L Bracket

Model	Option Description
R05-LM-02	LM4 Rubber Grommet
R21-LMX-02	License Bracket For LM4



R02-LM-01



R02-LM-02













R02-LM-05





R05-LM-02



R21-LMX-02

Optics	Model	LED Color	Compliance	LED
	*LM4F-41-R00		SAE J595, ECE R10	4
	*LM4F-41-B00		SAE J595, ECE R10	4
	*LM4F-41-A00		SAE J595, ECE R10	4
	*LM4F-41-C00		SAE J595, ECE R10	4
	*LM4F-41-G00		SAE J595, ECE R10	4
	*LM4F-41-M00		SAE J595, ECE R10	4
	LM4E-41-R00		SAE J595, ECE R10	4
	LM4E-41-B00		SAE J595, ECE R10, ECE R65 Class 2	4
	LM4E-41-A00		SAE J595, ECE R10, ECE R65 Class 2	4
	LM4E-41-C00		SAE J595, ECE R10	4
	LM4E-41-G00		SAE J595, ECE R10	4
	LM4E-41-M00		SAE J595, ECE R10	4
	LM4E-41-RA0		SAE J595, ECE R10	4
	LM4E-41-RB0		SAE J595, ECE R10	4
	LM4E-41-RC0		SAE J595, ECE R10	4
	LM4E-41-BA0		SAE J595, ECE R10	4
	LM4E-41-BC0		SAE J595, ECE R10	4
	LM4E-41-AC0		SAE J595, ECE R10	4
	LM4E-41-AG0		SAE J595, ECE R10	4
	*LM4E-41-CM0		SAE J595, ECE R10	4
	LM4E-41-CG0		SAE J595, ECE R10	4
	LM4C-41-R00		SAE J595, ECE R10	4
	LM4C-41-B00		SAE J595, ECE R10	4
	LM4C-41-A00		SAE J595, ECE R10	4
	LM4C-41-C00		SAE J595, ECE R10	4
	LM4C-41-G00		SAE J595, ECE R10	4
	LM4C-41-M00		SAE J595, ECE R10	4
	LM4C-41-RA0		SAE J595, ECE R10	4
	LM4C-41-RB0		SAE J595, ECE R10	4
	LM4C-41-RC0		SAE J595, ECE R10	4
	LM4C-41-BA0		SAE J595, ECE R10	4
	LM4C-41-BC0		SAE J595, ECE R10	4
	LM4C-41-AC0		SAE J595, ECE R10	4
	LM4C-41-AG0		SAE J595, ECE R10	4
	LM4C-41-CM0		SAE J595, ECE R10	4
	LM4C-41-CG0		SAE J595, ECE R10	4

*Production is contingent upon reaching a specified order quantity.

Optics	Model	LED Color	Compliance	LED
	LM4L-41-R00	●	SAE J595, ECE R10	4
	LM4L-41-B00	●	SAE J595, ECE R10	4
	LM4L-41-A00	●	SAE J595, ECE R10	4
	LM4L-41-C00	○	SAE J595, ECE R10	4
	LM4L-41-G00	●	SAE J595, ECE R10	4
	LM4L-41-M00	●	SAE J595, ECE R10	4
	LM4L-61-R00	●	SAE J595, ECE R10	6
	LM4L-61-B00	●	SAE J595, ECE R10	6
	LM4L-61-A00	●	SAE J595, ECE R10	6
	*LM4L-61-C00	○	SAE J595, ECE R10	6
	LM4L-61-G00	●	SAE J595, ECE R10	6
	LM4L-61-M00	●	SAE J595, ECE R10	6
	LM4L-61-RA0	●	SAE J595, ECE R10	6
	LM4L-61-RB0	●	SAE J595, ECE R10	6
	LM4L-61-RC0	●	SAE J595, ECE R10	6
	LM4L-61-BA0	●	SAE J595, ECE R10	6
	LM4L-61-BC0	●	SAE J595, ECE R10	6
	LM4L-61-AC0	●	SAE J595, ECE R10	6
	*LM4L-61-AG0	●	SAE J595, ECE R10	6
	LM4L-61-CM0	●	SAE J595, ECE R10	6
	*LM4L-61-CG0	●	SAE J595, ECE R10	6
	LM4L-81-R/A	●	SAE J595, ECE R10	8
	LM4L-81-R/B	●	SAE J595, ECE R10	8
	LM4L-81-R/C	●	SAE J595, ECE R10	8
	LM4L-81-B/A	●	SAE J595, ECE R10	8
	*LM4L-81-B/C	●	SAE J595, ECE R10	8
	LM4L-81-A/C	●	SAE J595, ECE R10	8
	LM4L-81-A/G	●	SAE J595, ECE R10	8
	*LM4L-81-C/M	●	SAE J595, ECE R10	8
	*LM4L-81-C/G	●	SAE J595, ECE R10	8
	LM4L-C1-Q01	●	SAE J595, ECE R10	12
		*LM4S-41-R00	●	SAE J595, ECE R10
*LM4S-41-B00		●	SAE J595, ECE R10	4
*LM4S-41-A00		●	SAE J595, ECE R10	4
*LM4S-41-C00		○	SAE J595, ECE R10	4
*LM4S-41-G00		●	SAE J595, ECE R10	4
*LM4S-41-M00		●	SAE J595, ECE R10	4
*LM4S-81-R/A		●	SAE J595, ECE R10	8
*LM4S-81-R/B		●	SAE J595, ECE R10	8
*LM4S-81-R/C		●	SAE J595, ECE R10	8
*LM4S-81-B/A		●	SAE J595, ECE R10	8
*LM4S-81-B/C		●	SAE J595, ECE R10	8
*LM4S-81-A/C		●	SAE J595, ECE R10	8
*LM4S-81-A/G		●	SAE J595, ECE R10	8
*LM4S-81-C/M		●	SAE J595, ECE R10	8
*LM4S-81-C/G	●	SAE J595, ECE R10	8	
	LM4R-41-R00	●	SAE J595, ECE R10	4
	LM4R-41-B00	●	SAE J595, ECE R10	4
	LM4R-41-A00	●	SAE J595, ECE R10	4
	LM4R-41-C00	○	SAE J595, ECE R10	4
	LM4R-41-G00	●	SAE J595, ECE R10	4
	LM4R-41-M00	●	SAE J595, ECE R10	4
	LM4R-61-RA0	●	SAE J595, ECE R10	6
	LM4R-61-RB0	●	SAE J595, ECE R10	6
	LM4R-61-RC0	●	SAE J595, ECE R10	6
	LM4R-61-BA0	●	SAE J595, ECE R10	6
	LM4R-61-BC0	●	SAE J595, ECE R10	6
	LM4R-61-AC0	●	SAE J595, ECE R10	6
	LM4R-61-AG0	●	SAE J595, ECE R10	6
	LM4R-61-CM0	●	SAE J595, ECE R10	6
	LM4R-61-CG0	●	SAE J595, ECE R10	6

*Production is contingent upon reaching a specified order quantity.

LM6 Mini Lighthouse Series

FEATURE

- Ingress Protection Rating: IP67 / IP69K
- Available in Single, Dual, Split and QUAD
- Input Voltage : 10~30VDC
- Input Current : 1.3A max@DC12V, 0.65A max@DC24V
- Flash Pattern: 30 (Single), 63 (Dual), 22 (QUAD)
- Ambient Temperature Range : -30~50°C
- Aluminium housing and PC Lens cover
- Accessories: Foam*1, Screws*2
- Mounting Option : Surface mount/ Bracket mount



DIMENSIONS

L5.13" x W0.69" x H0.97" (130.4 x 17.5 x 24.7 mm)

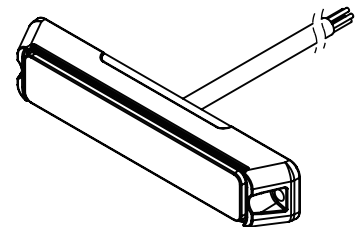
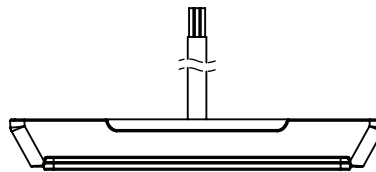
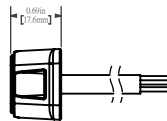
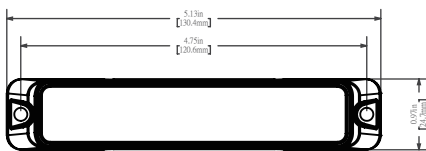

OPTIONAL ACCESSORIES:

Model	Option Description
R02-LM-01	L Bracket Screw Kits
R02-LM-02	C Bracket Screw Kits
R02-LM-04	L Bracket

Model	Option Description
R05-LM-03	LM6 Rubber Grommet
R21-LMX-01	License Bracket For LM6



R02-LM-01



R02-LM-02











































R02-LM-04



R05-LM-03





R21-LMX-01

Optics	Model	LED Color	Compliance	LED
	*LM6F-61-R00		SAE J595, ECE R10	6
	*LM6F-61-B00		SAE J595, ECE R10	6
	*LM6F-61-A00		SAE J595, ECE R10	6
	*LM6F-61-C00		SAE J595, ECE R10	6
	*LM6F-61-G00		SAE J595, ECE R10	6
	*LM6F-61-M00		SAE J595, ECE R10	6
	LM6E-61-R00		SAE J595, ECE R10	6
	LM6E-61-B00		SAE J595, ECE R10, ECE R65 Class 1	6
	LM6E-61-A00		SAE J595, ECE R10, ECE R65 Class 1	6
	LM6E-61-C00		SAE J595, ECE R10	6
	LM6E-61-G00		SAE J595, ECE R10	6
	LM6E-61-M00		SAE J595, ECE R10	6
	LM6E-61-RA0		SAE J595, ECE R10	6
	LM6E-61-RB0		SAE J595, ECE R10	6
	LM6E-61-RC0		SAE J595, ECE R10	6
	LM6E-61-BA0		SAE J595, ECE R10	6
	LM6E-61-BC0		SAE J595, ECE R10	6
	LM6E-61-AC0		SAE J595, ECE R10	6
	* LM6E-61-AG0		SAE J595, ECE R10	6
	*LM6E-61-CM0		SAE J595, ECE R10	6
	*LM6E-61-CG0		SAE J595, ECE R10	6
	LM6E-61-R/A		SAE J595, ECE R10	6
	LM6E-61-A/C		SAE J595, ECE R10	6
		LM6C-61-R00		SAE J595, ECE R10
LM6C-61-B00			SAE J595, ECE R10	6
LM6C-61-A00			SAE J595, ECE R10	6
LM6C-61-C00			SAE J595, ECE R10	6
LM6C-61-G00			SAE J595, ECE R10	6
LM6C-61-M00			SAE J595, ECE R10	6
LM6C-61-RA0			SAE J595, ECE R10	6
LM6C-61-RB0			SAE J595, ECE R10	6
LM6C-61-RC0			SAE J595, ECE R10	6
LM6C-61-BA0			SAE J595, ECE R10	6
LM6C-61-BC0			SAE J595, ECE R10	6
LM6C-61-AC0			SAE J595, ECE R10	6
LM6C-61-AG0			SAE J595, ECE R10	6
LM6C-61-CM0			SAE J595, ECE R10	6
LM6C-61-CG0			SAE J595, ECE R10	6

*Production is contingent upon reaching a specified order quantity.

Optics	Model	LED Color	Compliance	LED
	LM6L-61-R00	●	SAE J595, ECE R10	6
	LM6L-61-B00	●	SAE J595, ECE R10	6
	LM6L-61-A00	●	SAE J595, ECE R10	6
	LM6L-61-C00	●	SAE J595, ECE R10	6
	LM6L-61-G00	●	SAE J595, ECE R10	6
	*LM6L-61-M00	●	SAE J595, ECE R10	6
	LM6L-61-RA0	●	SAE J595, ECE R10	6
	LM6L-61-RB0	●	SAE J595, ECE R10	6
	LM6L-61-RC0	●	SAE J595, ECE R10	6
	LM6L-61-BA0	●	SAE J595, ECE R10	6
	LM6L-61-BC0	●	SAE J595, ECE R10	6
	LM6L-61-AC0	●	SAE J595, ECE R10	6
	*LM6L-61-AG0	●	SAE J595, ECE R10	6
	*LM6L-61-CM0	●	SAE J595, ECE R10	6
	*LM6L-61-CG0	●	SAE J595, ECE R10	6
	LM6L-C1-R00	●	SAE J595, ECE R10	12
	LM6L-C1-B00	●	SAE J595, ECE R10	12
	LM6L-C1-A00	●	SAE J595, ECE R10	12
	LM6L-C1-C00	●	SAE J595, ECE R10	12
	LM6L-C1-G00	●	SAE J595, ECE R10	12
	*LM6L-C1-M00	●	SAE J595, ECE R10	12
	*LM6L-C1-RA0	●	SAE J595, ECE R10	12
	LM6L-C1-RB0	●	SAE J595, ECE R10	12
	LM6L-C1-RC0	●	SAE J595, ECE R10	12
	LM6L-C1-BA0	●	SAE J595, ECE R10	12
	*LM6L-C1-BC0	●	SAE J595, ECE R10	12
	LM6L-C1-AC0	●	SAE J595, ECE R10	12
	*LM6L-C1-AG0	●	SAE J595, ECE R10	12
	*LM6L-C1-CM0	●	SAE J595, ECE R10	12
	*LM6L-C1-CG0	●	SAE J595, ECE R10	12
	LM6L-C1-R/A	●	SAE J595, ECE R10	12
	LM6L-C1-R/B	●	SAE J595, ECE R10	12
	LM6L-C1-R/C	●	SAE J595, ECE R10	12
	LM6L-C1-B/A	●	SAE J595, ECE R10	12
	LM6L-C1-B/C	●	SAE J595, ECE R10	12
	LM6L-C1-A/C	●	SAE J595, ECE R10	12
	*LM6L-C1-A/G	●	SAE J595, ECE R10	12
	*LM6L-C1-C/M	●	SAE J595, ECE R10	12
	*LM6L-C1-C/G	●	SAE J595, ECE R10	12
	LM6L-P1-Q01	●	SAE J595, ECE R10	24

*Production is contingent upon reaching a specified order quantity.

Optics	Model	LED Color	Compliance	LED	
	LM6S-61-R00	●	SAE J595, ECE R10	6	
	LM6S-61-B00	●	SAE J595, ECE R10	6	
	LM6S-61-A00	●	SAE J595, ECE R10	6	
	LM6S-61-C00	●	SAE J595, ECE R10	6	
	LM6S-61-G00	●	SAE J595, ECE R10	6	
	LM6S-61-M00	●	SAE J595, ECE R10	6	
	LM6S-61-RA0	●	SAE J595, ECE R10	6	
	*LM6S-61-RB0	●	SAE J595, ECE R10	6	
	LM6S-61-RC0	●	SAE J595, ECE R10	6	
	*LM6S-61-BA0	●	SAE J595, ECE R10	6	
	LM6S-61-BC0	●	SAE J595, ECE R10	6	
	LM6S-61-AC0	●	SAE J595, ECE R10	6	
	*LM6S-61-AG0	●	SAE J595, ECE R10	6	
	*LM6S-61-CM0	●	SAE J595, ECE R10	6	
	*LM6S-61-CG0	●	SAE J595, ECE R10	6	
	LM6S-C1-R00	●	SAE J595, ECE R10	12	
	LM6S-C1-B00	●	SAE J595, ECE R10	12	
	LM6S-C1-A00	●	SAE J595, ECE R10	12	
	LM6S-C1-C00	●	SAE J595, ECE R10	12	
	LM6S-C1-G00	●	SAE J595, ECE R10	12	
	LM6S-C1-M00	●	SAE J595, ECE R10	12	
	LM6S-C1-R/A	●	SAE J595, ECE R10	12	
	LM6S-C1-R/B	●	SAE J595, ECE R10	12	
	LM6S-C1-R/C	●	SAE J595, ECE R10	12	
	LM6S-C1-B/A	●	SAE J595, ECE R10	12	
	LM6S-C1-B/C	●	SAE J595, ECE R10	12	
	LM6S-C1-A/C	●	SAE J595, ECE R10	12	
	LM6S-C1-A/G	●	SAE J595, ECE R10	12	
	*LM6S-C1-C/M	●	SAE J595, ECE R10	12	
	*LM6S-C1-C/G	●	SAE J595, ECE R10	12	
		*LM6R-61-R00	●	SAE J595, ECE R10	6
		*LM6R-61-B00	●	SAE J595, ECE R10	6
		LM6R-61-A00	●	SAE J595, ECE R10	6
LM6R-61-C00		●	SAE J595, ECE R10	6	
*LM6R-61-G00		●	SAE J595, ECE R10	6	
*LM6R-61-M00		●	SAE J595, ECE R10	6	
LM6R-C1-R00		●	SAE J595, ECE R10	12	
LM6R-C1-B00		●	SAE J595, ECE R10	12	
LM6R-C1-A00		●	SAE J595, ECE R10	12	
LM6R-C1-C00		●	SAE J595, ECE R10	12	
LM6R-C1-G00		●	SAE J595, ECE R10	12	
LM6R-C1-M00		●	SAE J595, ECE R10	12	
LM6R-C1-R/A		●	SAE J595, ECE R10	12	
LM6R-C1-R/B		●	SAE J595, ECE R10	12	
LM6R-C1-R/C		●	SAE J595, ECE R10	12	
LM6R-C1-B/A		●	SAE J595, ECE R10	12	
LM6R-C1-B/C		●	SAE J595, ECE R10	12	
LM6R-C1-A/C		●	SAE J595, ECE R10	12	
LM6R-C1-A/G		●	SAE J595, ECE R10	12	
LM6R-C1-C/M		●	SAE J595, ECE R10	12	
LM6R-C1-C/G		●	SAE J595, ECE R10	12	

*Production is contingent upon reaching a specified order quantity.

LM6V Mini Lighthouse Series

FEATURE

- Vertical Optics
- Ingress Protection Rating: IP67 / IP69K
- Available in Single
- Input Voltage : 10~30VDC
- Input Current : 2.0A max@DC12V, 1.2A max@DC24V
- Flash Pattern: 13
- Ambient Temperature Range : -30~50°C
- Housing: Aluminum
- Accessories: Foam*1, Screws*2

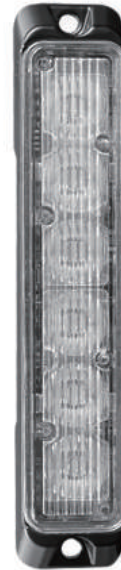

DIMENSIONS

L5.13" x W0.73" x H0.97" (130.4 x 18.5 x 24.7 mm)

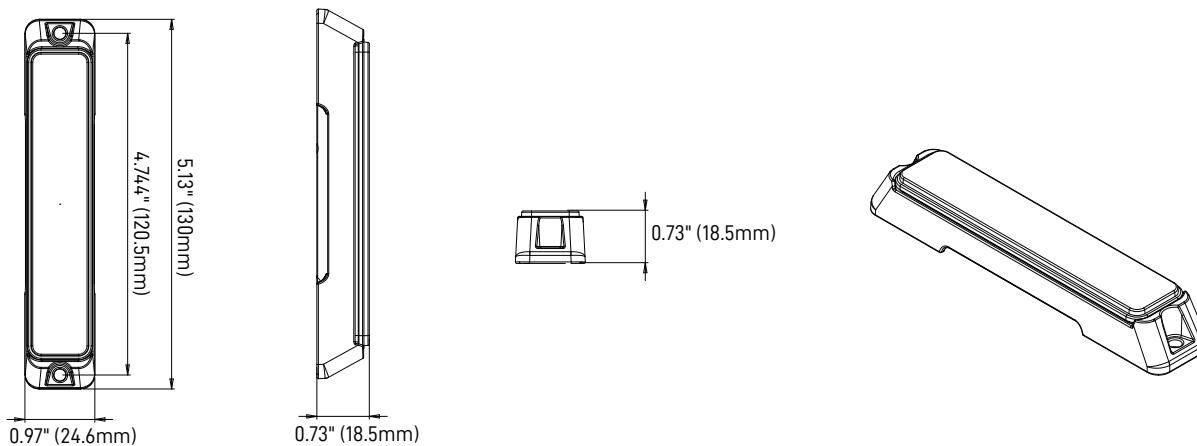

Model	LED Color	Compliance	Optics	LED
*LM6V-61-R00	●	SAE J595, ECE R10	Vertical	6
LM6V-61-B00	●	SAE J595, ECE R10, ECE R65 Class2	Vertical	6
LM6V-61-A00	●	SAE J595, ECE R10, ECE R65 Class2	Vertical	6
*LM6V-61-C00	●	SAE J595, ECE R10	Vertical	6
*LM6V-61-G00	●	SAE J595, ECE R10	Vertical	6
*LM6V-61-M00	●	SAE J595, ECE R10	Vertical	6

*Production is contingent upon reaching a specified order quantity.

LMC Mini Lighthouse Series

FEATURE

- Ingress Protection Rating: IP67 / IP69K
- Available in Single, Dual and QUAD
- Input Voltage : 10~30VDC
- Input Current : 1.3A max@DC12V, 0.65A max@DC24V
- Flash Pattern: 30 (Single), 63 (Dual), 22 (QUAD)
- Ambient Temperature Range : -30~50°C
- Aluminium housing and PC Lens cover
- Accessories: Foam*1, Screws*2
- Mounting Option : Surface mount/ Bracket mount



DIMENSIONS

L5.37" x W0.69" x H1.19" (136.34 x 17.40 x 30.17 mm)

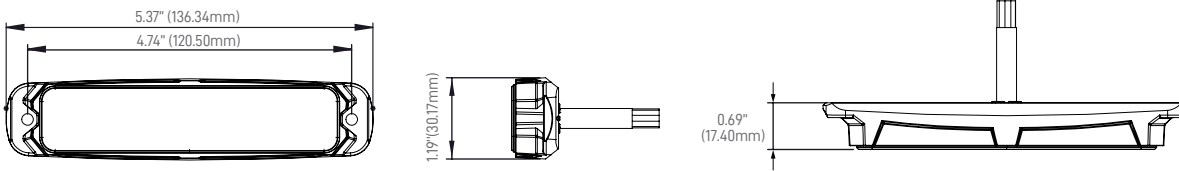

OPTIONAL ACCESSORIES:

Model	Option Description
R02-LM-01	L Bracket Screw Kits
R02-LM-02	C Bracket Screw Kits
R02-LM-04	L Bracket



Optics	Model	LED Color	Compliance	LED
	*LMC6F-61-R00	●	SAE J595, ECE R10	6
	*LMC6F-61-B00	●	SAE J595, ECE R10	6
	*LMC6F-61-A00	●	SAE J595, ECE R10	6
	*LMC6F-61-C00	●	SAE J595, ECE R10	6
	*LMC6E-61-R00	●	SAE J595, ECE R10	6
	*LMC6E-61-B00	●	SAE J595, ECE R10, ECE R65 Class 1	6
	LMC6E-61-A00	●	SAE J595, ECE R10, ECE R65 Class 1	6
	*LMC6E-61-C00	●	SAE J595, ECE R10	6
	*LMC6C-61-R00	●	SAE J595, ECE R10	6
	LMC6C-61-B00	●	SAE J595, ECE R10	6
	LMC6C-61-A00	●	SAE J595, ECE R10	6
	*LMC6C-61-C00	●	SAE J595, ECE R10	6
	*LMC6L-61-R00	●	SAE J595, ECE R10	6
	*LMC6L-61-B00	●	SAE J595, ECE R10	6
	*LMC6L-61-A00	●	SAE J595, ECE R10	6
	*LMC6L-61-C00	●	SAE J595, ECE R10	6
	*LMC6L-C1-R/A	●	SAE J595, ECE R10, ECE R65 Class 1	12
	*LMC6L-C1-R/B	●	SAE J595, ECE R10, ECE R65 Class 1	12
	*LMC6L-C1-R/C	●	SAE J595, ECE R10	12
	*LMC6L-C1-B/A	●	SAE J595, ECE R10, ECE R65 Class 1	12
	*LMC6L-C1-B/C	●	SAE J595, ECE R10	12
	*LMC6L-C1-A/C	●	SAE J595, ECE R10	12
	LMC6L-P1-Q01	●	SAE J595, ECE R10, ECE R65 Class 1	24
		*LMC6S-61-R00	●	SAE J595, ECE R10
*LMC6S-61-B00		●	SAE J595, ECE R10	6
*LMC6S-61-A00		●	SAE J595, ECE R10	6
*LMC6S-61-C00		●	SAE J595, ECE R10	6
*LMC6S-C1-R/A		●	SAE J595, ECE R10	12
*LMC6S-C1-R/B		●	SAE J595, ECE R10	12
*LMC6S-C1-R/C		●	SAE J595, ECE R10	12
*LMC6S-C1-B/A		●	SAE J595, ECE R10	12
*LMC6S-C1-B/C		●	SAE J595, ECE R10	12
*LMC6S-C1-A/C		●	SAE J595, ECE R10	12
	*LMC6R-61-R00	●	SAE J595, ECE R10	6
	*LMC6R-61-B00	●	SAE J595, ECE R10	6
	*LMC6R-61-A00	●	SAE J595, ECE R10	6
	*LMC6R-61-C00	●	SAE J595, ECE R10	6
	*LMC6R-C1-R/A	●	SAE J595, ECE R10	12
	*LMC6R-C1-R/B	●	SAE J595, ECE R10	12
	*LMC6R-C1-R/C	●	SAE J595, ECE R10	12
	*LMC6R-C1-B/A	●	SAE J595, ECE R10	12
	*LMC6R-C1-B/C	●	SAE J595, ECE R10	12
	LMC6R-C1-A/C	●	SAE J595, ECE R10	12

*Production is contingent upon reaching a specified order quantity.

LR8F *Rectangle Flat Series*

FEATURE

- Focus Optics
- Ingress Protection Rating: IP67/ IP69K
- Available in Single And Dual
- Input Voltage: 10~30VDC
- Input Current: 1.2A max@DC12V, 1.0A max@DC24V
- Flash Pattern: 21 (Single), 54 (Dual)
- Ambient Temperature Range: -30~70°C
- Accessories: Screws
- Mounting Options:
 - Surface mount with bezel by screw
 - Surface mount with adhesive
- Synchronizable up to 8 lights



DIMENSIONS

L2.36" x W1.92" x H0.3" (60 x 49 x 8 mm)

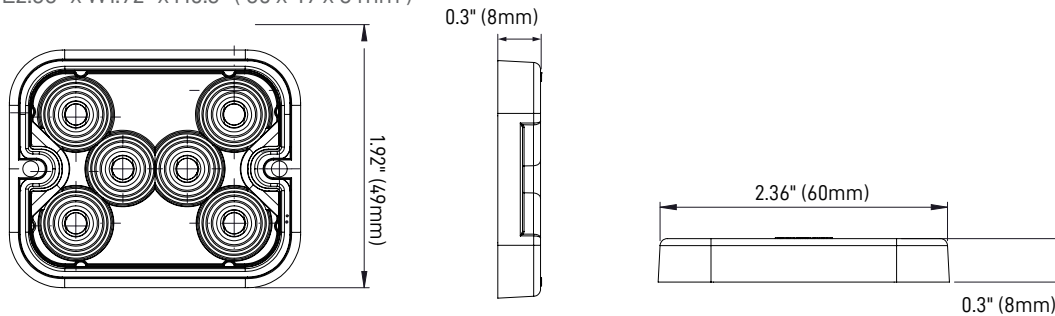

Model	LED Color	Compliance	Optics	LED
*LR8F-61-R00		SAE J595, CA T13, ECE R10	Focus	6
*LR8F-61-B00		SAE J595, CA T13, ECE R10	Focus	6
LR8F-61-A00		SAE J595, CA T13, ECE R10	Focus	6
*LR8F-61-C00		SAE J595, CA T13, ECE R10	Focus	6
*LR8F-61-R/A		SAE J595, CA T13, ECE R10	Focus	6
*LR8F-61-R/B		SAE J595, CA T13, ECE R10	Focus	6
*LR8F-61-R/C		SAE J595, CA T13, ECE R10	Focus	6
LR8F-61-B/A		SAE J595, CA T13, ECE R10	Focus	6
*LR8F-61-B/C		SAE J595, CA T13, ECE R10	Focus	6
LR8F-61-A/C		SAE J595, CA T13, ECE R10	Focus	6

*Production is contingent upon reaching a specified order quantity.

LL2 Series

FEATURE

- Ingress Protection Rating: IP67
- Available in Single, Dual and Split
- Input Voltage: 10~30VDC
- Input Current: 0.5Amax@DC12V, 0.3Amax@DC24V
- Flash Pattern: 15(Single), 37 (Dual)
- Ambient Temperature Range: -30~50°C
- Accessories: EVA Gasket*1, Screws *2
- Mounting Options: Brackets
- Synchronizable up to 8 lights



DIMENSIONS

L3.06" x W2.73" x H1.06" (77.7 x 69.3 x 27 mm)

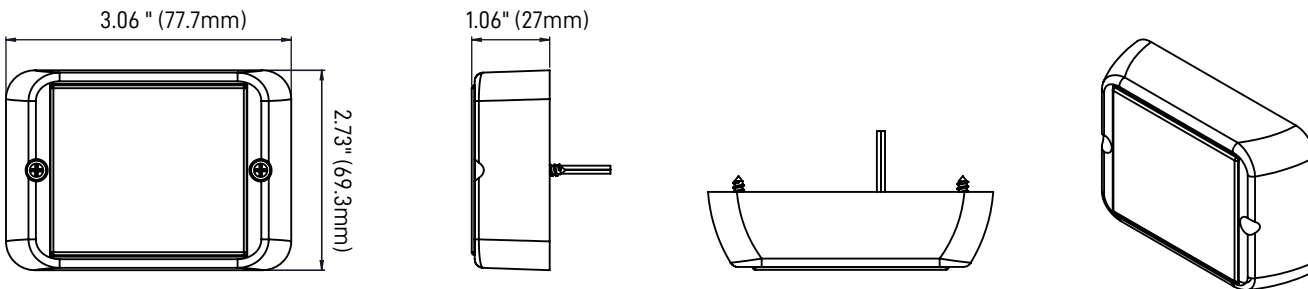

ACCESSORIES:











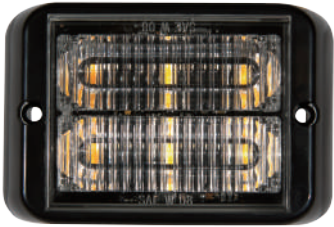



























Model	Description
R01-L-13	3 Light Double Layer High Flange



R01-L-13

Optics	Model	LED Color	Compliance	LED
	*LL2F-61-R00	●	SAE J595, ECE R10	6
	*LL2F-61-B00	●	SAE J595, ECE R10	6
	*LL2F-61-A00	●	SAE J595, ECE R10	6
	*LL2F-61-C00	○	SAE J595, ECE R10	6
	*LL2F-61-G00	●	SAE J595, ECE R10	6
	*LL2F-61-M00	●	SAE J595, ECE R10	6
	*LL2E-61-R00	●	SAE J595, ECE R10	6
	*LL2E-61-B00	●	SAE J595, ECE R10	6
	*LL2E-61-A00	●	SAE J595, ECE R10	6
	*LL2E-61-C00	○	SAE J595, ECE R10	6
	*LL2E-61-G00	●	SAE J595, ECE R10	6
	*LL2E-61-M00	●	SAE J595, ECE R10	6
	*LL2C-61-R00	●	SAE J595, ECE R10	6
	*LL2C-61-B00	●	SAE J595, ECE R10	6
	*LL2C-61-A00	●	SAE J595, ECE R10	6
	*LL2C-61-C00	○	SAE J595, ECE R10	6
	*LL2C-61-G00	●	SAE J595, ECE R10	6
	*LL2C-61-M00	●	SAE J595, ECE R10	6
	LL2L-61-R00	●	SAE J595, ECE R10	6
	LL2L-61-B00	●	SAE J595, ECE R10	6
	LL2L-61-A00	●	SAE J595, ECE R10	6
	LL2L-61-C00	○	SAE J595, ECE R10	6
	*LL2L-61-G00	●	SAE J595, ECE R10	6
	*LL2L-61-M00	●	SAE J595, ECE R10	6
	LL2L-C1-R00	●	SAE J595, ECE R10	12
	LL2L-C1-B00	●	SAE J595, ECE R10	12
	LL2L-C1-A00	●	SAE J595, ECE R10	12
	LL2L-C1-C00	○	SAE J595, ECE R10	12
	*LL2L-C1-G00	●	SAE J595, ECE R10	12
	*LL2L-C1-M00	●	SAE J595, ECE R10	12
	*LL2L-C1-RA0	●	SAE J595, ECE R10	12
	LL2L-C1-RB0	●	SAE J595, ECE R10	12
	LL2L-C1-RC0	●	SAE J595, ECE R10	12
	*LL2L-C1-BA0	●	SAE J595, ECE R10	12
	*LL2L-C1-BC0	●	SAE J595, ECE R10	12
	*LL2L-C1-AC0	●	SAE J595, ECE R10	12

*Production is contingent upon reaching a specified order quantity.

Optics	Model	LED Color	Compliance	LED
	*LL2S-61-R00		SAE J595, ECE R10	6
	*LL2S-61-B00		SAE J595, ECE R10	6
	*LL2S-61-A00		SAE J595, ECE R10	6
	*LL2S-61-C00		SAE J595, ECE R10	6
	*LL2S-61-G00		SAE J595, ECE R10	6
	*LL2S-61-M00		SAE J595, ECE R10	6
	*LL2S-C1-R00		SAE J595, ECE R10	12
	*LL2S-C1-B00		SAE J595, ECE R10	12
	*LL2S-C1-A00		SAE J595, ECE R10	12
	*LL2S-C1-C00		SAE J595, ECE R10	12
	*LL2S-C1-G00		SAE J595, ECE R10	12
	*LL2S-C1-M00		SAE J595, ECE R10	12
	*LL2S-C1-R/A		SAE J595, ECE R10	12
	*LL2S-C1-R/B		SAE J595, ECE R10	12
	*LL2S-C1-R/C		SAE J595, ECE R10	12
	*LL2S-C1-B/A		SAE J595, ECE R10	12
	*LL2S-C1-B/C		SAE J595, ECE R10	12
	*LL2S-C1-A/C		SAE J595, ECE R10	12
	*LL2R-61-R00		SAE J595, ECE R10	6
	*LL2R-61-B00		SAE J595, ECE R10	6
	*LL2R-61-A00		SAE J595, ECE R10	6
	*LL2R-61-C00		SAE J595, ECE R10	6
	*LL2R-61-G00		SAE J595, ECE R10	6
	*LL2R-61-M00		SAE J595, ECE R10	6
	*LL2R-C1-R00		SAE J595, ECE R10	12
	*LL2R-C1-B00		SAE J595, ECE R10	12
	*LL2R-C1-A00		SAE J595, ECE R10	12
	*LL2R-C1-C00		SAE J595, ECE R10	12
	*LL2R-C1-G00		SAE J595, ECE R10	12
	*LL2R-C1-M00		SAE J595, ECE R10	12
	*LL2R-C1-R/A		SAE J595, ECE R10	12
	*LL2R-C1-R/B		SAE J595, ECE R10	12
	*LL2R-C1-R/C		SAE J595, ECE R10	12
	*LL2R-C1-B/A		SAE J595, ECE R10	12
	*LL2R-C1-B/C		SAE J595, ECE R10	12
	*LL2R-C1-A/C		SAE J595, ECE R10	12

*Production is contingent upon reaching a specified order quantity.

LL3 Series

FEATURE

- Ingress Protection Rating: IP67
- Available in Single, Dual and Quad
- Input Voltage: 10~30VDC
- Input Current: 0.6Amax@DC12V, 0.3Amax@DC24V
- Flash Pattern: 15 (Single), 37 (Dual)
- Ambient Temperature Range: -30~50°C
- Accessories: EVA Gasket*1, Screws *2
- Mounting Options: Brackets
- Synchronizable up to 8 lights



DIMENSIONS

L3.89" x W1.06" x H1.49" (98.9 x 27 x 37.9 mm)

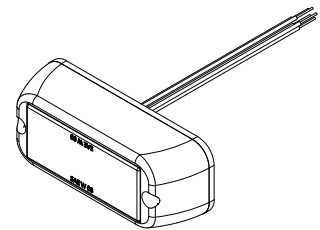
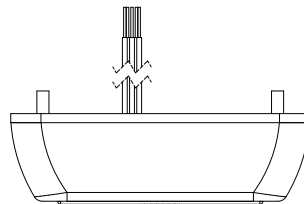
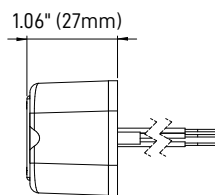
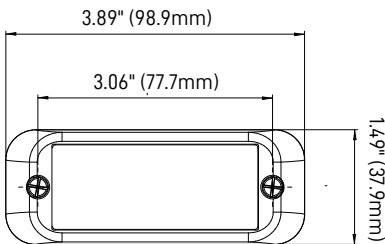

ACCESSORIES:

Model	Description
R01-L-01	L3x Black High Flange
R01-L-04	L3x Black Low Flange
R02-L-01	L3XL Bracket Screw Kits (Black)







R01-L-01



R01-L-04
(Option)

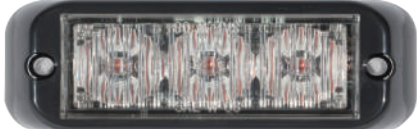

R02-L-01
(Option)

Optics	Model	LED Color	Compliance	LED	
	*LL3F-31-R00	●	SAE J595, ECE R10	3	
	*LL3F-31-B00	●	SAE J595, ECE R10	3	
	*LL3F-31-A00	●	SAE J595, ECE R10	3	
	*LL3F-31-C00	●	SAE J595, ECE R10	3	
	*LL3F-31-G00	●	SAE J595, ECE R10	3	
	*LL3F-31-M00	●	SAE J595, ECE R10	3	
	LL3E-31-R00	●	SAE J595, ECE R10	3	
	LL3E-31-B00	●	SAE J595, ECE R10	3	
	LL3E-31-A00	●	SAE J595, ECE R10	3	
	LL3E-31-C00	●	SAE J595, ECE R10	3	
	LL3E-31-G00	●	SAE J595, ECE R10	3	
	LL3E-31-M00	●	SAE J595, ECE R10	3	
	LL3C-31-R00	●	SAE J595, ECE R10	3	
	*LL3C-31-B00	●	SAE J595, ECE R10	3	
	LL3C-31-A00	●	SAE J595, ECE R10	3	
	*LL3C-31-C00	●	SAE J595, ECE R10	3	
	LL3C-31-G00	●	SAE J595, ECE R10	3	
	*LL3C-31-M00	●	SAE J595, ECE R10	3	
	*LL3L-31-R00	●	SAE J595, ECE R10	3	
	*LL3L-31-B00	●	SAE J595, ECE R10	3	
	*LL3L-31-A00	●	SAE J595, ECE R10	3	
	*LL3L-31-C00	●	SAE J595, ECE R10	3	
	*LL3L-31-G00	●	SAE J595, ECE R10	3	
	*LL3L-31-M00	●	SAE J595, ECE R10	3	
	*LL3L-61-R/A	●	SAE J595, ECE R10	6	
	*LL3L-61-R/B	●	SAE J595, ECE R10	6	
	*LL3L-61-R/C	●	SAE J595, ECE R10	6	
	*LL3L-61-B/A	●	SAE J595, ECE R10	6	
	*LL3L-61-B/C	●	SAE J595, ECE R10	6	
	*LL3L-61-A/C	●	SAE J595, ECE R10	6	
	*LL3L-C1-Q01	●	SAE J595, ECE R10	12	
		*LL3S-31-R00	●	SAE J595, ECE R10	3
*LL3S-31-B00		●	SAE J595, ECE R10	3	
*LL3S-31-A00		●	SAE J595, ECE R10	3	
*LL3S-31-C00		●	SAE J595, ECE R10	3	
*LL3S-31-G00		●	SAE J595, ECE R10	3	
*LL3S-31-M00		●	SAE J595, ECE R10	3	
*LL3S-61-R/A		●	SAE J595, ECE R10	6	
*LL3S-61-R/B		●	SAE J595, ECE R10	6	
*LL3S-61-R/C		●	SAE J595, ECE R10	6	
*LL3S-61-B/A		●	SAE J595, ECE R10	6	
*LL3S-61-B/C		●	SAE J595, ECE R10	6	
*LL3S-61-A/C		●	SAE J595, ECE R10	6	
		*LL3R-31-R00	●	SAE J595, ECE R10	3
		*LL3R-31-B00	●	SAE J595, ECE R10	3
	*LL3R-31-A00	●	SAE J595, ECE R10	3	
	*LL3R-31-C00	●	SAE J595, ECE R10	3	
	*LL3R-31-G00	●	SAE J595, ECE R10	3	
	*LL3R-31-M00	●	SAE J595, ECE R10	3	
	*LL3R-61-R/A	●	SAE J595, ECE R10	6	
	*LL3R-61-R/B	●	SAE J595, ECE R10	6	
	*LL3R-61-R/C	●	SAE J595, ECE R10	6	
	*LL3R-61-B/A	●	SAE J595, ECE R10	6	
	*LL3R-61-B/C	●	SAE J595, ECE R10	6	
	*LL3R-61-A/C	●	SAE J595, ECE R10	6	

*Production is contingent upon reaching a specified order quantity.

LL4 Series

FEATURE

- Ingress Protection Rating: IP67
- Available in Single and Dual
- Input Voltage: 10~30VDC
- Input Current: 0.65Amax@DC12V, 0.45Amax@DC24V
- Flash Pattern: 25 (Single), 37 (Dual)
- Ambient Temperature Range: -30~50°C
- Accessories: EVA Gasket*1, Screws *2
- Mounting Options: Brackets
- Synchronizable up to 8 lights



DIMENSIONS

L4.72" x W1.06" x H1.49" (119.9 x 27 x 37.9 mm)

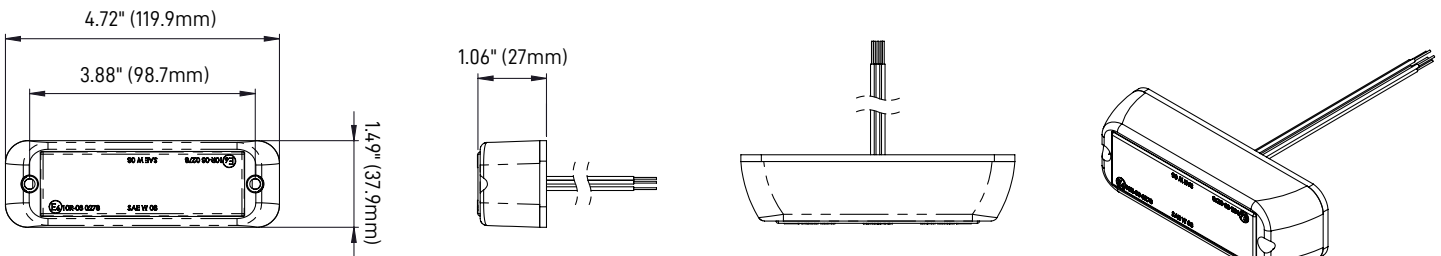

ACCESSORIES:







Model	Description
R01-L-02	L4XL Bracket Screw Kits (Black)
R02-L-02	L4x Black High Flange



R01-L-02

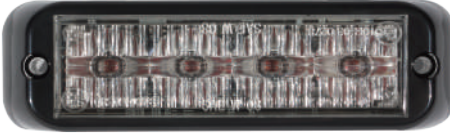

R02-L -02
(Option)

Optics	Model	LED Color	Compliance	LED
	*LL4F-41-R00	●	SAE J595, ECE R10	4
	*LL4F-41-B00	●	SAE J595, ECE R10	4
	*LL4F-41-A00	●	SAE J595, ECE R10	4
	*LL4F-41-C00	●	SAE J595, ECE R10	4
	*LL4F-41-G00	●	SAE J595, ECE R10	4
	*LL4E-41-R00	●	SAE J595, ECE R10	4
	LL4E-41-B00	●	SAE J595, ECE R10	4
	LL4E-41-A00	●	SAE J595, ECE R10	4
	*LL4E-41-C00	●	SAE J595, ECE R10	4
	*LL4E-41-G00	●	SAE J595, ECE R10	4
	*LL4E-41-M00	●	SAE J595, ECE R10	4
	LL4C-41-R00	●	SAE J595, ECE R10	4
	LL4C-41-B00	●	SAE J595, ECE R10	4
	LL4C-41-A00	●	SAE J595, ECE R10	4
	LL4C-41-C00	●	SAE J595, ECE R10	4
	LL4C-41-G00	●	SAE J595, ECE R10	4
	LL4C-41-M00	●	SAE J595, ECE R10	4
	*LL4L-41-R00	●	SAE J595, ECE R10	4
	*LL4L-41-B00	●	SAE J595, ECE R10	4
	*LL4L-41-A00	●	SAE J595, ECE R10	4
	*LL4L-41-C00	●	SAE J595, ECE R10	4
	*LL4L-41-G00	●	SAE J595, ECE R10	4
	*LL4L-41-M00	●	SAE J595, ECE R10	4
	*LL4L-81-R/A	●	SAE J595, ECE R10	8
	*LL4L-81-R/B	●	SAE J595, ECE R10	8
	*LL4L-81-R/C	●	SAE J595, ECE R10	8
	*LL4L-81-B/A	●	SAE J595, ECE R10	8
	*LL4L-81-B/C	●	SAE J595, ECE R10	8
	*LL4L-81-A/C	●	SAE J595, ECE R10	8
	*LL4S-41-R00	●	SAE J595, ECE R10	4
	*LL4S-41-B00	●	SAE J595, ECE R10	4
	*LL4S-41-A00	●	SAE J595, ECE R10	4
	*LL4S-41-C00	●	SAE J595, ECE R10	4
	*LL4S-41-G00	●	SAE J595, ECE R10	4
	*LL4S-41-M00	●	SAE J595, ECE R10	4
	*LL4S-81-R/A	●	SAE J595, ECE R10	8
	*LL4S-81-R/B	●	SAE J595, ECE R10	8
	*LL4S-81-R/C	●	SAE J595, ECE R10	8
	*LL4S-81-B/A	●	SAE J595, ECE R10	8
	*LL4S-81-B/C	●	SAE J595, ECE R10	8
	*LL4S-81-A/C	●	SAE J595, ECE R10	8
	*LL4R-41-R00	●	SAE J595, ECE R10	4
	*LL4R-41-B00	●	SAE J595, ECE R10	4
	*LL4R-41-A00	●	SAE J595, ECE R10	4
	*LL4R-41-C00	●	SAE J595, ECE R10	4
	*LL4R-41-G00	●	SAE J595, ECE R10	4
	*LL4R-41-M00	●	SAE J595, ECE R10	4
	*LL4R-81-R/A	●	SAE J595, ECE R10	8
*LL4R-81-R/B	●	SAE J595, ECE R10	8	
*LL4R-81-R/C	●	SAE J595, ECE R10	8	
*LL4R-81-B/A	●	SAE J595, ECE R10	8	
*LL4R-81-B/C	●	SAE J595, ECE R10	8	
*LL4R-81-A/C	●	SAE J595, ECE R10	8	

*Production is contingent upon reaching a specified order quantity.

LL5 Series

FEATURE

- Ingress Protection Rating: IP67
- Available in Single, Split and Dual
- Input Voltage: 10~30VDC
- Input Current: 1.2Amax@DC12V, 0.7Amax@DC24V
- Flash Pattern: 37 (Dual)
- Ambient Temperature Range: -30~50°C
- Accessories: EVA Gasket*1, Screws *2
- Mounting Options: Brackets
- Synchronizable up to 8 lights



DIMENSIONS

L4.72" x W2.89" x H1.18" (119.9 x 73.3 x 30 mm)

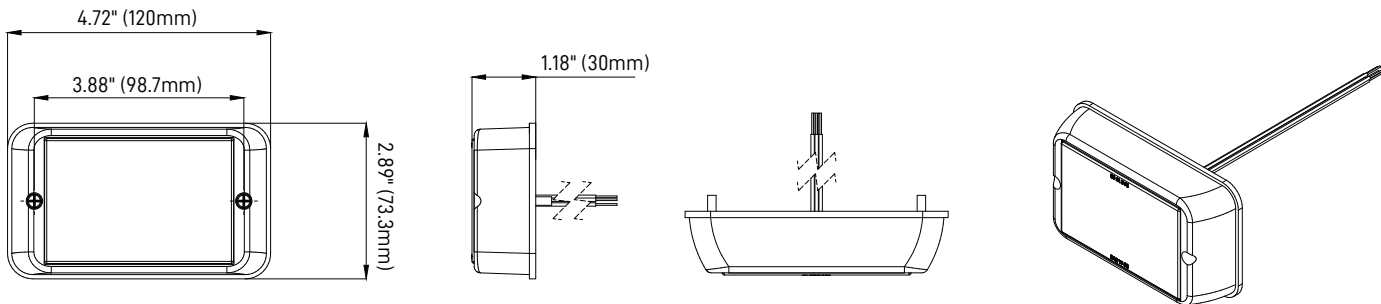



ACCESSORIES:





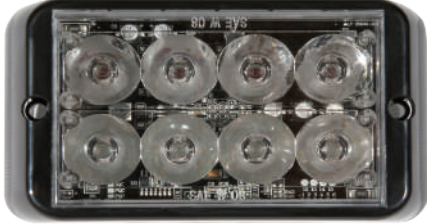





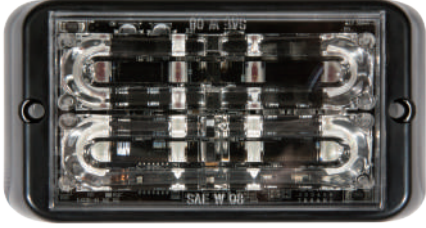















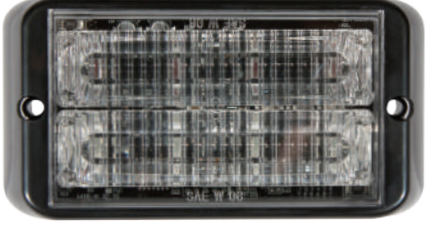















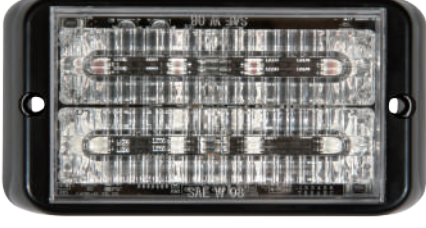





Model	Description
R01-L-14	4 Light Double Layer High Flange



R01-L-14

Optics	Model	LED Color	Compliance	LED
	*LL5F-81-R00	●	SAE J595, ECE R10	8
	*LL5F-81-B00	●	SAE J595, ECE R10	8
	*LL5F-81-A00	●	SAE J595, ECE R10	8
	*LL5F-81-C00	○	SAE J595, ECE R10	8
	*LL5F-81-G00	●	SAE J595, ECE R10	8
	*LL5F-81-M00	●	SAE J595, ECE R10	8
	LL5E-41-R00	●	SAE J595, ECE R10	4
	LL5E-41-B00	●	SAE J595, ECE R10	4
	*LL5E-41-A00	●	SAE J595, ECE R10	4
	*LL5E-41-C00	○	SAE J595, ECE R10	4
	*LL5E-41-G00	●	SAE J595, ECE R10	4
	*LL5E-41-M00	●	SAE J595, ECE R10	4
	LL5E-81-R00	●	SAE J595, ECE R10	8
	LL5E-81-B00	●	SAE J595, ECE R10	8
	*LL5E-81-A00	●	SAE J595, ECE R10	8
	*LL5E-81-C00	○	SAE J595, ECE R10	8
	*LL5E-81-G00	●	SAE J595, ECE R10	8
	*LL5E-81-M00	●	SAE J595, ECE R10	8
	*LL5E-81-RA0	●	SAE J595, ECE R10	8
	*LL5E-81-RB0	●	SAE J595, ECE R10	8
	*LL5E-81-RC0	●	SAE J595, ECE R10	8
	*LL5E-81-BA0	●	SAE J595, ECE R10	8
	*LL5E-81-BC0	●	SAE J595, ECE R10	8
	LL5E-81-AC0	●	SAE J595, ECE R10	8
	*LL5E-81-AG0	●	SAE J595, ECE R10	8
	*LL5E-81-CM0	●	SAE J595, ECE R10	8
*LL5E-81-CG0	●	SAE J595, ECE R10	8	
	*LL5C-81-R00	●	SAE J595, ECE R10	8
	*LL5C-81-B00	●	SAE J595, ECE R10	8
	*LL5C-81-A00	●	SAE J595, ECE R10	8
	*LL5C-81-C00	○	SAE J595, ECE R10	8
	*LL5C-81-G00	●	SAE J595, ECE R10	8
	LL5C-81-M00	●	SAE J595, ECE R10	8
	LL5C-81-RA0	●	SAE J595, ECE R10	8
	*LL5C-81-RB0	●	SAE J595, ECE R10	8
	LL5C-81-RC0	●	SAE J595, ECE R10	8
	*LL5C-81-BA0	●	SAE J595, ECE R10	8
	*LL5C-81-BC0	●	SAE J595, ECE R10	8
	LL5C-81-AC0	●	SAE J595, ECE R10	8
	*LL5C-81-AG0	●	SAE J595, ECE R10	8
	*LL5C-81-CM0	●	SAE J595, ECE R10	8
	LL5C-81-CG0	●	SAE J595, ECE R10	8

*Production is contingent upon reaching a specified order quantity.

Optics	Model	LED Color	Compliance	LED
	*LL5L-81-R00		SAE J595, ECE R10	8
	*LL5L-81-B00		SAE J595, ECE R10	8
	*LL5L-81-A00		SAE J595, ECE R10	8
	*LL5L-81-C00		SAE J595, ECE R10	8
	*LL5L-81-G00		SAE J595, ECE R10	8
	*LL5L-81-M00		SAE J595, ECE R10	8
	*LL5L-81-RA0		SAE J595, ECE R10	8
	LL5L-81-RB0		SAE J595, ECE R10	8
	*LL5L-81-RC0		SAE J595, ECE R10	8
	*LL5L-81-BA0		SAE J595, ECE R10	8
	*LL5L-81-BC0		SAE J595, ECE R10	8
	LL5L-81-AC0		SAE J595, ECE R10	8
	*LL5L-81-AG0		SAE J595, ECE R10	8
	*LL5L-81-CM0		SAE J595, ECE R10	8
	*LL5L-81-CG0		SAE J595, ECE R10	8
	LL5L-C1-RC0		SAE J595, ECE R10	12
	*LL5S-81-R00		SAE J595, ECE R10	8
	*LL5S-81-B00		SAE J595, ECE R10	8
	*LL5S-81-A00		SAE J595, ECE R10	8
	*LL5S-81-C00		SAE J595, ECE R10	8
	*LL5S-81-G00		SAE J595, ECE R10	8
	*LL5S-81-M00		SAE J595, ECE R10	8
	*LL5S-81-RA0		SAE J595, ECE R10	8
	*LL5S-81-RB0		SAE J595, ECE R10	8
	*LL5S-81-RC0		SAE J595, ECE R10	8
	*LL5S-81-BA0		SAE J595, ECE R10	8
	*LL5S-81-BC0		SAE J595, ECE R10	8
	*LL5S-81-AC0		SAE J595, ECE R10	8
	*LL5S-81-AG0		SAE J595, ECE R10	8
	*LL5S-81-CM0		SAE J595, ECE R10	8
	*LL5S-81-CG0		SAE J595, ECE R10	8
		LL5R-81-R00		SAE J595, ECE R10
LL5R-81-B00			SAE J595, ECE R10	8
LL5R-81-A00			SAE J595, ECE R10	8
LL5R-81-C00			SAE J595, ECE R10	8
LL5R-81-G00			SAE J595, ECE R10	8
LL5R-81-M00			SAE J595, ECE R10	8
LL5R-81-RA0			SAE J595, ECE R10	8
LL5R-81-RB0			SAE J595, ECE R10	8
LL5R-81-RC0			SAE J595, ECE R10	8
LL5R-81-BA0			SAE J595, ECE R10	8
LL5R-81-BC0			SAE J595, ECE R10	8
LL5R-81-AC0			SAE J595, ECE R10	8
LL5R-81-AG0			SAE J595, ECE R10	8
LL5R-81-CM0			SAE J595, ECE R10	8
LL5R-81-CG0			SAE J595, ECE R10	8

LL6 Series

FEATURE

- Ingress Protection Rating: IP67
- Available in Single and Dual
- Input Voltage: 10~30VDC
- Input Current: 1.3Amax@DC12V, 0.75Amax@DC24V
- Flash Pattern: 25(Single), 37(Dual)
- Ambient Temperature Range: -30~50°C
- Accessories: EVA Gasket*1, Screws *2
- Mounting Options: Brackets
- Synchronizable up to 8 lights



DIMENSIONS

L6.37" x W1.06" x H1.49" (162 x 27 x 37.9 mm)

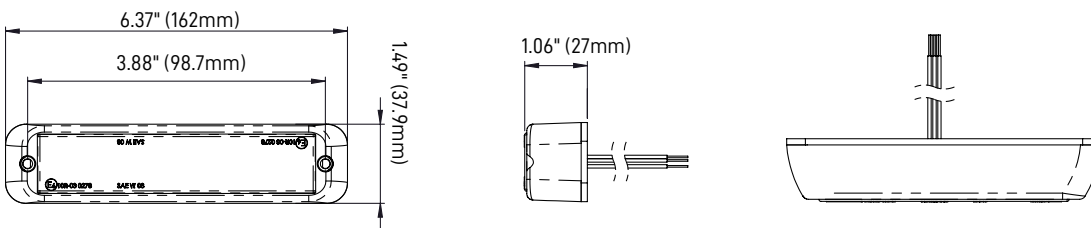

OPTIONAL ACCESSORIES:































Model	Option Description
R02-L-03	L6XL Bracket Screw Kits (Black)



R02-L -03

Optics	Model	LED Color	Compliance	LED
	*LL6F-61-R00	●	SAE J595, ECE R10	6
	*LL6F-61-B00	●	SAE J595, ECE R10	6
	*LL6F-61-A00	●	SAE J595, ECE R10	6
	LL6F-61-C00	○	SAE J595, ECE R10	6
	*LL6F-61-G00	●	SAE J595, ECE R10	6
	*LL6F-61-M00	●	SAE J595, ECE R10	6
	*LL6F-61-RA0	●	SAE J595, ECE R10	6
	*LL6F-61-RB0	●	SAE J595, ECE R10	6
	*LL6F-61-RC0	●	SAE J595, ECE R10	6
	LL6F-61-BA0	●	SAE J595, ECE R10	6
	*LL6F-61-BC0	●	SAE J595, ECE R10	6
	LL6F-61-AC0	●	SAE J595, ECE R10	6
	*LL6F-61-AG0	●	SAE J595, ECE R10	6
	*LL6F-61-CM0	●	SAE J595, ECE R10	6
	*LL6F-61-CG0	●	SAE J595, ECE R10	6
	*LL6E-61-R00	●	SAE J595, ECE R10	6
	*LL6E-61-B00	●	SAE J595, ECE R10	6
	*LL6E-61-A00	●	SAE J595, ECE R10	6
	*LL6E-61-C00	○	SAE J595, ECE R10	6
	*LL6E-61-G00	●	SAE J595, ECE R10	6
	*LL6E-61-M00	●	SAE J595, ECE R10	6
	*LL6E-61-RA0	●	SAE J595, ECE R10	6
	LL6E-61-RB0	●	SAE J595, ECE R10	6
	*LL6E-61-RC0	●	SAE J595, ECE R10	6
	*LL6E-61-BA0	●	SAE J595, ECE R10	6
	*LL6E-61-BC0	●	SAE J595, ECE R10	6
	LL6E-61-AC0	●	SAE J595, ECE R10	6
	*LL6E-61-AG0	●	SAE J595, ECE R10	6
	*LL6E-61-CM0	●	SAE J595, ECE R10	6
	*LL6E-61-CG0	●	SAE J595, ECE R10	6
	*LL6C-61-R00	●	SAE J595, ECE R10	6
	*LL6C-61-B00	●	SAE J595, ECE R10	6
	*LL6C-61-A00	●	SAE J595, ECE R10	6
	*LL6C-61-C00	○	SAE J595, ECE R10	6
	*LL6C-61-G00	●	SAE J595, ECE R10	6
	*LL6C-61-M00	●	SAE J595, ECE R10	6
	*LL6C-61-RA0	●	SAE J595, ECE R10	6
	*LL6C-86-RB0	●	SAE J595, ECE R10	6
	*LL6C-61-RC0	●	SAE J595, ECE R10	6
	*LL6C-61-BA0	●	SAE J595, ECE R10	6
	*LL6C-61-BC0	●	SAE J595, ECE R10	6
	*LL6C-61-AC0	●	SAE J595, ECE R10	6
	*LL6C-61-AG0	●	SAE J595, ECE R10	6
	*LL6C-61-CM0	●	SAE J595, ECE R10	6
	*LL6C-61-CG0	●	SAE J595, ECE R10	6

*Production is contingent upon reaching a specified order quantity.

Optics	Model	LED Color	Compliance	LED
	LL6L-61-R00		SAE J595, ECE R10	6
	LL6L-61-B00		SAE J595, ECE R10, ECE R65 Class 1	6
	LL6L-61-A00		SAE J595, ECE R10	6
	LL6L-61-C00		SAE J595, ECE R10	6
	*LL6L-61-G00		SAE J595, ECE R10	6
	*LL6L-61-M00		SAE J595, ECE R10	6
	LL6L-61-RA0		SAE J595, ECE R10	6
	LL6L-61-RB0		SAE J595, ECE R10	6
	*LL6L-61-RC0		SAE J595, ECE R10	6
	*LL6L-61-BA0		SAE J595, ECE R10	6
	LL6L-61-BC0		SAE J595, ECE R10	6
	LL6L-61-AC0		SAE J595, ECE R10	6
	*LL6L-61-AG0		SAE J595, ECE R10	6
	*LL6L-61-CM0		SAE J595, ECE R10	6
	*LL6L-61-CG0		SAE J595, ECE R10	6
	LL6L-C1-R00		SAE J595, ECE R10	12
	LL6L-C1-B00		SAE J595, ECE R10	12
	LL6L-C1-A00		SAE J595, ECE R10	12
	LL6L-C1-C00		SAE J595, ECE R10	12
	*LL6L-C1-G00		SAE J595, ECE R10	12
	LL6L-C1-M00		SAE J595, ECE R10	12
	LL6L-C1-R/A		SAE J595, ECE R10	12
	LL6L-C1-R/B		SAE J595, ECE R10	12
	LL6L-C1-R/C		SAE J595, ECE R10	12
	LL6L-C1-B/A		SAE J595, ECE R10	12
	LL6L-C1-B/C		SAE J595, ECE R10	12
	LL6L-C1-A/C		SAE J595, ECE R10	12
	LL6L-C1-A/G		SAE J595, ECE R10	12
	*LL6L-C1-C/M		SAE J595, ECE R10	12
	*LL6L-C1-C/G		SAE J595, ECE R10	12

*Production is contingent upon reaching a specified order quantity.

Optics	Model	LED Color	Compliance	LED
	*LL6S-61-R00	●	SAE J595, ECE R10	6
	*LL6S-61-B00	●	SAE J595, ECE R10	6
	*LL6S-61-A00	●	SAE J595, ECE R10	6
	*LL6S-61-C00	●	SAE J595, ECE R10	6
	*LL6S-61-G00	●	SAE J595, ECE R10	6
	*LL6S-61-M00	●	SAE J595, ECE R10	6
	*LL6S-61-R/A	●	SAE J595, ECE R10	6
	*LL6S-61-R/B	●	SAE J595, ECE R10	6
	*LL6S-61-R/C	●	SAE J595, ECE R10	6
	*LL6S-61-B/A	●	SAE J595, ECE R10	6
	*LL6S-61-B/C	●	SAE J595, ECE R10	6
	*LL6S-61-A/C	●	SAE J595, ECE R10	6
	*LL6S-61-A/G	●	SAE J595, ECE R10	6
	*LL6S-61-C/M	●	SAE J595, ECE R10	6
	*LL6S-61-C/G	●	SAE J595, ECE R10	6
		LL6R-C1-R00	●	SAE J595, ECE R10
LL6R-C1-B00		●	SAE J595, ECE R10	12
LL6R-C1-A00		●	SAE J595, ECE R10	12
LL6R-C1-C00		●	SAE J595, ECE R10	12
LL6R-C1-G00		●	SAE J595, ECE R10	12
LL6R-C1-M00		●	SAE J595, ECE R10	12
*LL6R-C1-RA0		●	SAE J595, ECE R10	12
LL6R-C1-RB0		●	SAE J595, ECE R10	12
LL6R-C1-RC0		●	SAE J595, ECE R10	12
*LL6R-C1-BA0		●	SAE J595, ECE R10	12
*LL6R-C1-BC0		●	SAE J595, ECE R10	12
*LL6R-C1-AC0		●	SAE J595, ECE R10	12
*LL6R-C1-AG0		●	SAE J595, ECE R10	12
*LL6R-C1-CM0		●	SAE J595, ECE R10	12
*LL6R-C1-CG0		●	SAE J595, ECE R10	12

*Production is contingent upon reaching a specified order quantity.

LBJ8 Octagon shape All In One Series

FEATURE

- Linear Optics
- Ingress Protection Rating: IP67, IP69
- Available in Single and Dual
- Available in 6 High power LEDs , 2 illuminate LEDs
- Input Voltage: 10~30VDC
- Input Current: 1.5A max@DC12.8V
- Flash Pattern: 16 (Single), 24 (Dual)
- Ambient Temperature Range: -30~70°C
- Synchronizable up to 8 lights



DIMENSIONS

L1.57" x W1.51" x D1.51" (39.9 x 38.3 x 38.3 mm)

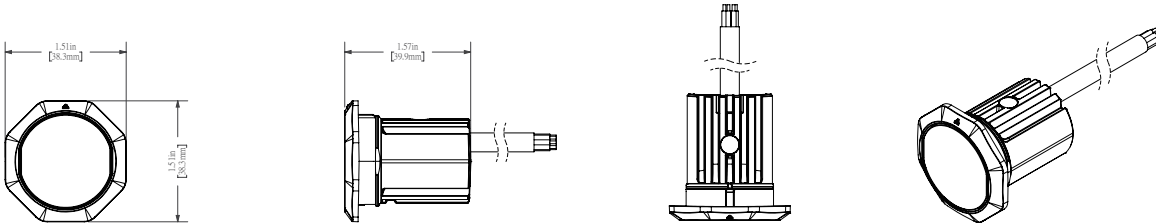

Model	LED Color	Compliance	LED
LBJ8-81-R00	●	SAE J595, CA T13, ECE R65 Class 2	8
LBJ8-81-B00	●	SAE J595, CA T13, ECE R65 Class 2	8
LBJ8-81-A00	●	SAE J595, CA T13, ECE R65 Class 2	8
LBJ8-81-R/A	●	SAE J595, CA T13, ECE R65 Class 1	8
LBJ8-81-R/B	●	SAE J595, CA T13, ECE R65 Class 1	8
LBJ8-81-R/C	●	SAE J595, CA T13, ECE R65 Class 1	8
LBJ8-81-B/A	●	SAE J595, CA T13, ECE R65 Class 1	8
LBJ8-81-B/C	●	SAE J595, CA T13, ECE R65 Class 1	8
LBJ8-81-A/C	●	SAE J595, CA T13, ECE R65 Class 1	8

ALL IN ONE Series



LBP



LBR



LBD



LBE



LBF



LBA



LBU



LBQ



LBN



LBG

FEATURE

- Ingress Protection Rating: IP67
- Available in Single
- Input Voltage: 10~30VDC
- Input Current:
0.8A-1.5A max@DC12V, 0.4A-0.75A max@DC24V
- Flash Pattern: 21
- Ambient Temperature Range: -30~50°C
- Housing: Aluminum
- Accessories: EVA Gasket*1, Screws *2
- Mounting Options:
 - Square L Bracket
 - Oval C Bracket
 - Black or Painted Chrome Bezel
 - Grommet
- Synchronizable up to 8 lights

DIMENSIONS

H0.99" x W1.78" (25.1 x 45.1 mm)

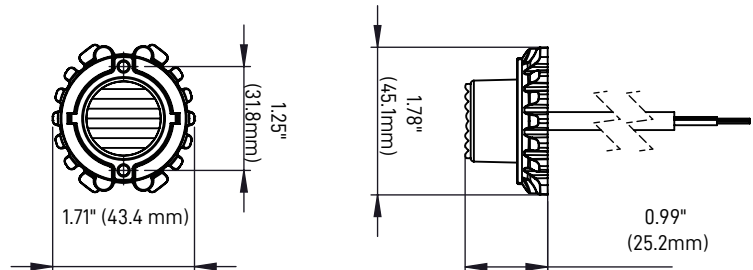

OPTIONAL ACCESSORIES:

Model	Option Description
R05-LH-01	Rubber Grommet Kits
R01-LH-02	Bezel + Foam + Screw(Black)
R01-LH-04	Bezel + Foam + Screw(Silver)
R02-LH-01	Oval C Bracket Screw Kits
R02-LH-02	Square L Bracket Screw Kits
R02-LH-03	C Bracket Screw Kits



R05-LH-01



R01-LH-02



R01-LH-04



R02-LH-01



R02-LH-02



R02-LH-03



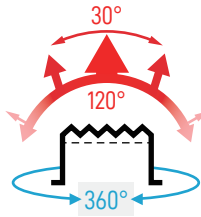
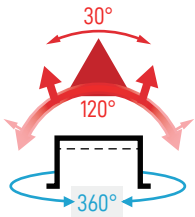



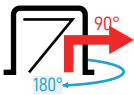



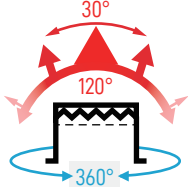

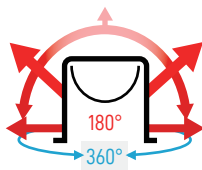

















































LBF					LBE				
Optics	Model	LED Color	Compliance	LED	Optics	Model	LED Color	Compliance	LED
TIR	*LBF-41-R00	●	SAE J595	4	TIR+Diffuser	LBE-41-R00	●	SAE J595	4
	*LBF-41-B00	●	SAE J595	4		LBE-41-B00	●	SAE J595, ECE R10, ECE R65 Class 1	4
	*LBF-41-A00	●	SAE J595	4		LBE-41-A00	●	SAE J595, ECE R10, ECE R65 Class 1	4
	*LBF-41-C00	○	SAE J595	4		LBE-41-C00	○	SAE J595	4
	*LBF-41-G00	●	SAE J595	4		LBE-41-G00	●	SAE J595	4
	*LBF-41-M00	●	SAE J595	4		*LBE-41-M00	●	SAE J595	4
	*LBF-41-R/A	●	SAE J595	4		*LBE-41-RA0	●	SAE J595	4
	*LBF-41-R/B	●	SAE J595	4		*LBE-41-RB0	●	SAE J595	4
	*LBF-41-R/C	●	SAE J595	4		*LBE-41-RC0	●	SAE J595	4
	*LBF-41-B/A	●	SAE J595	4		*LBE-41-BA0	●	SAE J595	4
	*LBF-41-B/C	●	SAE J595	4		*LBE-41-BC0	●	SAE J595	4
	*LBF-41-A/C	●	SAE J595	4		*LBE-41-AC0	●	SAE J595	4
	*LBF-41-A/G	●	SAE J595	4		*LBE-41-AG0	●	SAE J595	4
	*LBF-41-C/M	●	SAE J595	4		*LBE-41-CM0	●	SAE J595	4
	*LBF-41-C/G	●	SAE J595	4		*LBE-41-CG0	●	SAE J595	4
	*LBF-41-RA0	●	SAE J595	4		LBE-61-R00	●	SAE J595	6
	*LBF-41-RB0	●	SAE J595	4		LBE-61-B00	●	SAE J595	6
	*LBF-41-RC0	●	SAE J595	4		LBE-61-A00	●	SAE J595	6
	*LBF-41-BA0	●	SAE J595	4		LBE-61-C00	○	SAE J595	6
	*LBF-41-BC0	●	SAE J595	4		LBE-61-G00	●	SAE J595	6
*LBF-41-AC0	●	SAE J595	4	LBE-61-M00	●	SAE J595	6		
*LBF-41-AG0	●	SAE J595	4	LBE-61-R/A	●	SAE J595	6		
*LBF-41-CM0	●	SAE J595	4	LBE-61-R/B	●	SAE J595	6		
*LBF-41-CG0	●	SAE J595	4	LBE-61-R/C	●	SAE J595	6		
LBF-61-R00	●	SAE J595	6	LBE-61-B/A	●	SAE J595	6		
LBF-61-B00	●	SAE J595	6	LBE-61-B/C	●	SAE J595	6		
LBF-61-A00	●	SAE J595	6	LBE-61-A/C	●	SAE J595	6		
LBF-61-C00	○	SAE J595	6	*LBE-61-A/G	●	SAE J595	6		
LBF-61-G00	●	SAE J595	6	*LBE-61-C/M	●	SAE J595	6		
LBF-61-M00	●	SAE J595	6	LBE-61-C/G	●	SAE J595	6		
LBF-61-R/A	●	SAE J595	6						
LBF-61-R/B	●	SAE J595	6						
LBF-61-R/C	●	SAE J595	6						
*LBF-61-B/A	●	SAE J595	6						
LBF-61-B/C	●	SAE J595	6						
LBF-61-A/C	●	SAE J595	6						
*LBF-61-A/G	●	SAE J595	6						
*LBF-61-C/M	●	SAE J595	6						
LBF-61-C/G	●	SAE J595	6						













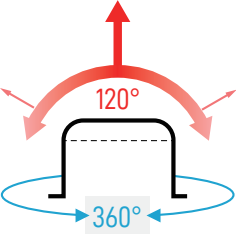



























































LBA				
Optics	Model	LED Color	Compliance	LED
Cylinder with 90°	LBA-41-R00	●	SAE J595	4
	LBA-41-B00	●	SAE J595	4
	LBA-41-A00	●	SAE J595	4
	LBA-41-C00	○	SAE J595	4
	LBA-41-G00	●	SAE J595	4
	LBA-41-M00	●	SAE J595	4













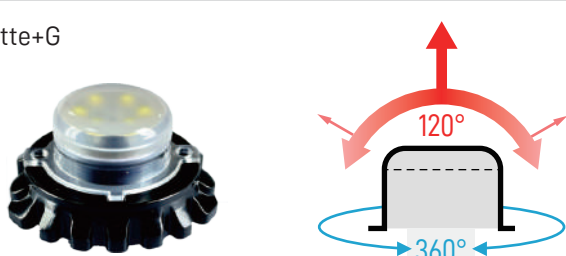

























































*Production is contingent upon reaching a specified order quantity.

LBD				LBP			
Model	LED Color	Compliance	LED	Model	LED Color	Compliance	LED
E+Flat cover				Cylinder with 360°			
							
LBD-41-R00		SAE J595	4	LBP-61-R00		SAE J595, ECE R10	6
LBD-41-B00		SAE J595, ECE R10, ECE R65 Class 1	4	LBP-61-B00		SAE J595, ECE R10	6
*LBD-41-A00		SAE J595, ECE R10, ECE R65 Class 1	4	LBP-61-A00		SAE J595, ECE R10	6
*LBD-41-C00		SAE J595	4	LBP-61-C00		SAE J595, ECE R10	6
*LBD-41-G00		SAE J595	4	LBP-61-G00		SAE J595, ECE R10	6
*LBD-41-M00		SAE J595	4	LBP-61-M00		SAE J595, ECE R10	6
*LBD-41-RA0		SAE J595	4	*LBP-61-R/A		SAE J595, ECE R10	6
*LBD-41-RB0		SAE J595	4	LBP-61-R/B		SAE J595, ECE R10	6
*LBD-41-RC0		SAE J595	4	LBP-61-R/C		SAE J595, ECE R10	6
*LBD-41-BA0		SAE J595	4	LBP-61-B/A		SAE J595, ECE R10	6
*LBD-41-BC0		SAE J595	4	LBP-61-B/C		SAE J595, ECE R10	6
*LBD-41-AC0		SAE J595	4	LBP-61-A/C		SAE J595, ECE R10	6
*LBD-41-AG0		SAE J595	4	*LBP-61-A/G		SAE J595, ECE R10	6
*LBD-41-CM0		SAE J595	4	*LBP-61-C/M		SAE J595, ECE R10	6
*LBD-41-CG0		SAE J595	4	*LBP-61-C/G		SAE J595, ECE R10	6
*LBD-61-R00		SAE J595	6	LBP-81-R00		SAE J595	8
*LBD-61-B00		SAE J595	6	LBP-81-B00		SAE J595	8
*LBD-61-A00		SAE J595	6	LBP-81-A00		SAE J595	8
*LBD-61-C00		SAE J595	6	LBP-81-C00		SAE J595	8
*LBD-61-G00		SAE J595	6	*LBP-81-G00		SAE J595	8
*LBD-61-M00		SAE J595	6	*LBP-81-M00		SAE J595	8
*LBD-61-R/A		SAE J595	6	*LBP-81-R/A		SAE J595	8
*LBD-61-R/B		SAE J595	6	*LBP-81-R/B		SAE J595	8
*LBD-61-R/C		SAE J595	6	*LBP-81-R/C		SAE J595	8
*LBD-61-B/A		SAE J595	6	*LBP-81-B/A		SAE J595	8
*LBD-61-B/C		SAE J595	6	*LBP-81-B/C		SAE J595	8
*LBD-61-A/C		SAE J595	6	*LBP-81-A/C		SAE J595	8
*LBD-61-A/G		SAE J595	6	*LBP-81-A/G		SAE J595	8
*LBD-61-C/M		SAE J595	6	*LBP-81-C/M		SAE J595	8
*LBD-61-C/G		SAE J595	6	*LBP-81-C/G		SAE J595	8











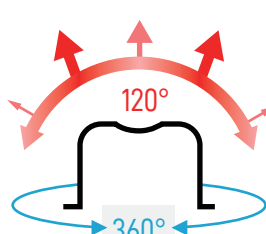

























































*Production is contingent upon reaching a specified order quantity.

LBG				LBG			
Model	LED Color	Compliance	LED	Model	LED Color	Compliance	LED
<p>Super slim dome</p>  				LBG-81-R00		SAE J595	8
				LBG-81-B00		SAE J595	8
				LBG-81-A00		SAE J595	8
				LBG-81-C00		SAE J595	8
				*LBG-81-G00		SAE J595	8
				*LBG-81-M00		SAE J595	8
*LBG-41-R00		SAE J595	4	LBG-81-R/A		SAE J595	8
*LBG-41-B00		SAE J595	4	LBG-81-R/B		SAE J595	8
*LBG-41-A00		SAE J595	4	LBG-81-R/C		SAE J595	8
*LBG-41-C00		SAE J595	4	LBG-81-B/A		SAE J595	8
*LBG-41-G00		SAE J595	4	LBG-81-B/C		SAE J595	8
*LBG-41-M00		SAE J595	4	LBG-81-A/C		SAE J595	8
*LBG-41-RA0		SAE J595	4	LBG-81-A/G		SAE J595	8
*LBG-41-RB0		SAE J595	4	*LBG-81-C/M		SAE J595	8
*LBG-41-RC0		SAE J595	4	*LBG-81-C/G		SAE J595	8
*LBG-41-BA0		SAE J595	4	LBG-C1-R00		SAE J595	12
*LBG-41-BC0		SAE J595	4	LBG-C1-B00		SAE J595	12
*LBG-41-AC0		SAE J595	4	LBG-C1-A00		SAE J595	12
*LBG-41-AG0		SAE J595	4	LBG-C1-C00		SAE J595	12
*LBG-41-CM0		SAE J595	4	LBG-C1-G00		SAE J595	12
*LBG-41-CG0		SAE J595	4	LBG-C1-M00		SAE J595	12
LBG-61-R00		SAE J595	6	*LBG-C1-R/A		SAE J595	12
LBG-61-B00		SAE J595	6	LBG-C1-R/B		SAE J595	12
LBG-61-A00		SAE J595	6	LBG-C1-R/C		SAE J595	12
LBG-61-C00		SAE J595	6	*LBG-C1-B/A		SAE J595	12
LBG-61-G00		SAE J595	6	LBG-C1-B/C		SAE J595	12
LBG-61-M00		SAE J595	6	*LBG-C1-A/C		SAE J595	12
LBG-61-R/A		SAE J595	6	*LBG-C1-A/G		SAE J595	12
LBG-61-R/B		SAE J595	6	*LBG-C1-C/M		SAE J595	12
LBG-61-R/C		SAE J595	6	*LBG-C1-C/G		SAE J595	12
LBG-61-B/A		SAE J595	6	LBG-C1-RA0		SAE J595	12
LBG-61-B/C		SAE J595	6	LBG-C1-RB0		SAE J595	12
LBG-61-A/C		SAE J595	6	LBG-C1-RC0		SAE J595	12
*LBG-61-A/G		SAE J595	6	LBG-C1-BA0		SAE J595	12
*LBG-61-C/M		SAE J595	6	LBG-C1-BC0		SAE J595	12
*LBG-61-C/G		SAE J595	6	LBG-C1-AC0		SAE J595	12
				*LBG-C1-AG0		SAE J595	12
				*LBG-C1-CM0		SAE J595	12
				*LBG-C1-CG0		SAE J595	12

*Production is contingent upon reaching a specified order quantity.

LBQ				LBQ			
Model	LED Color	Compliance	LED	Model	LED Color	Compliance	LED
Matte+G 				*LBQ-81-R00  SAE J595 8 *LBQ-81-B00  SAE J595 8 *LBQ-81-A00  SAE J595 8 *LBQ-81-C00  SAE J595 8 *LBQ-81-G00  SAE J595 8 *LBQ-81-M00  SAE J595 8 *LBQ-81-R/A  SAE J595 8 *LBQ-81-R/B  SAE J595 8 *LBQ-81-R/C  SAE J595 8 *LBQ-81-B/A  SAE J595 8 *LBQ-81-B/C  SAE J595 8 *LBQ-81-A/C  SAE J595 8 *LBQ-81-A/G  SAE J595 8 *LBQ-81-C/M  SAE J595 8 *LBQ-81-C/G  SAE J595 8 *LBQ-C1-R00  SAE J595 12 *LBQ-C1-B00  SAE J595 12 *LBQ-C1-A00  SAE J595 12 *LBQ-C1-C00  SAE J595 12 *LBQ-C1-G00  SAE J595 12 *LBQ-C1-M00  SAE J595 12 *LBQ-C1-R/A  SAE J595 12 *LBQ-C1-R/B  SAE J595 12 *LBQ-C1-R/C  SAE J595 12 *LBQ-C1-B/A  SAE J595 12 *LBQ-C1-B/C  SAE J595 12 *LBQ-C1-A/C  SAE J595 12 *LBQ-C1-A/G  SAE J595 12 *LBQ-C1-C/M  SAE J595 12 *LBQ-C1-C/G  SAE J595 12 *LBQ-C1-RA0  SAE J595 12 *LBQ-C1-RB0  SAE J595 12 *LBQ-C1-RC0  SAE J595 12 *LBQ-C1-BA0  SAE J595 12 *LBQ-C1-BC0  SAE J595 12 *LBQ-C1-AC0  SAE J595 12 *LBQ-C1-AG0  SAE J595 12 *LBQ-C1-CM0 SAE J595 12 *LBQ-C1-CG0 SAE J595 12			
*LBQ-41-R00		SAE J595	4				
*LBQ-41-B00		SAE J595	4				
*LBQ-41-A00		SAE J595	4				
*LBQ-41-C00		SAE J595	4				
*LBQ-41-G00		SAE J595	4				
*LBQ-1-M00		SAE J595	4				
*LBQ-41-RA0		SAE J595	4				
*LBQ-41-RB0		SAE J595	4				
*LBQ-41-RC0		SAE J595	4				
*LBQ-41-BA0		SAE J595	4				
*LBQ-41-BC0		SAE J595	4				
*LBQ-41-AC0		SAE J595	4				
*LBQ-41-AG0		SAE J595	4				
*LBQ-41-CM0		SAE J595	4				
*LBQ-41-CG0		SAE J595	4				
*LBQ-61-R00		SAE J595	6				
*LBQ-61-B00		SAE J595	6				
*LBQ-61-A00		SAE J595	6				
*LBQ-61-C00		SAE J595	6				
*LBQ-61-G00		SAE J595	6				
*LBQ-61-M00		SAE J595	6				
*LBQ-61-R/A		SAE J595	6				
*LBQ-61-R/B		SAE J595	6				
*LBQ-61-R/C		SAE J595	6				
*LBQ-61-B/A		SAE J595	6				
*LBQ-61-B/C		SAE J595	6				
*LBQ-61-A/C		SAE J595	6				
*LBQ-61-A/G		SAE J595	6				
*LBQ-61-C/M		SAE J595	6				
*LBQ-61-C/G		SAE J595	6				

*Production is contingent upon reaching a specified order quantity.











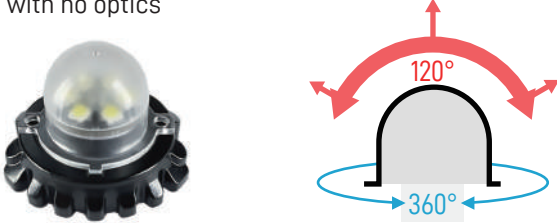



























































LBN				LBN			
Model	LED Color	Compliance	LED	Model	LED Color	Compliance	LED
Navel with no optics  				*LBN-81-R00  SAE J595 8 *LBN-81-B00  SAE J595 8 *LBN-81-A00  SAE J595 8 *LBN-81-C00  SAE J595 8 *LBN-81-G00  SAE J595 8 *LBN-81-M00  SAE J595 8 *LBN-81-R/A  SAE J595 8 *LBN-81-R/B  SAE J595 8 *LBN-81-R/C  SAE J595 8 *LBN-81-B/A  SAE J595 8 *LBN-81-B/C  SAE J595 8 *LBN-81-A/C  SAE J595 8 *LBN-81-A/G  SAE J595 8 *LBN-81-C/M  SAE J595 8 *LBN-81-C/G  SAE J595 8 *LBN-C1-R00  SAE J595 12 *LBN-C1-B00  SAE J595 12 *LBN-C1-A00  SAE J595 12 LBN-C1-C00  SAE J595 12 *LBN-C1-G00  SAE J595 12 *LBN-C1-M00  SAE J595 12 *LBN-C1-R/A  SAE J595 12 *LBN-C1-R/B  SAE J595 12 LBN-C1-R/C  SAE J595 12 *LBN-C1-B/A  SAE J595 12 LBN-C1-B/C  SAE J595 12 *LBN-C1-A/C  SAE J595 12 *LBN-C1-A/G  SAE J595 12 *LBN-C1-C/M  SAE J595 12 *LBN-C1-C/G  SAE J595 12 *LBN-C1-RA0  SAE J595 12 *LBN-C1-RB0  SAE J595 12 *LBN-C1-RC0  SAE J595 12 *LBN-C1-BA0  SAE J595 12 *LBN-C1-BC0  SAE J595 12 *LBN-C1-AC0  SAE J595 12 *LBN-C1-AG0  SAE J595 12 *LBN-C1-CM0 SAE J595 12 *LBN-C1-CG0 SAE J595 12			
*LBN-41-R00		SAE J595	4				
*LBN-41-B00		SAE J595	4				
*LBN-41-A00		SAE J595	4				
*LBN-41-C00		SAE J595	4				
*LBN-41-G00		SAE J595	4				
*LBN-41-M00		SAE J595	4				
*LBN-41-RA0		SAE J595	4				
*LBN-41-RB0		SAE J595	4				
*LBN-41-RC0		SAE J595	4				
*LBN-41-BA0		SAE J595	4				
*LBN-41-BC0		SAE J595	4				
*LBN-41-AC0		SAE J595	4				
*LBN-41-AG0		SAE J595	4				
*LBN-41-CM0		SAE J595	4				
*LBN-41-CG0		SAE J595	4				
LBN-61-R00		SAE J595	6				
LBN-61-B00		SAE J595	6				
LBN-61-A00		SAE J595	6				
LBN-61-C00		SAE J595	6				
LBN-61-G00		SAE J595	6				
*LBN-61-M00		SAE J595	6				
*LBN-61-R/A		SAE J595	6				
LBN-61-R/B		SAE J595	6				
LBN-61-R/C		SAE J595	6				
LBN-61-B/A		SAE J595	6				
LBN-61-B/C		SAE J595	6				
LBN-61-A/C		SAE J595	6				
LBN-61-A/G		SAE J595	6				
*LBN-61-C/M		SAE J595	6				
LBN-61-C/G		SAE J595	6				

*Production is contingent upon reaching a specified order quantity.

LBU			
Model	LED Color	Compliance	LED
Matte+N			
*LBU-41-R00		SAE J595	4
*LBU-41-B00		SAE J595	4
*LBU-41-A00		SAE J595	4
*LBU-41-C00		SAE J595	4
*LBU-41-G00		SAE J595	4
*LBU-41-M00		SAE J595	4
*LBU-41-RA0		SAE J595	4
*LBU-41-RB0		SAE J595	4
*LBU-41-RC0		SAE J595	4
*LBU-41-BA0		SAE J595	4
*LBU-41-BC0		SAE J595	4
*LBU-41-AC0		SAE J595	4
*LBU-41-AG0		SAE J595	4
*LBU-41-CM0		SAE J595	4
*LBU-41-CG0		SAE J595	4
*LBU-61-R00		SAE J595	6
*LBU-61-B00		SAE J595	6
*LBU-61-A00		SAE J595	6
*LBU-61-C00		SAE J595	6
*LBU-61-G00		SAE J595	6
*LBU-61-M00		SAE J595	6
*LBU-61-R/A		SAE J595	6
*LBU-61-R/B		SAE J595	6
*LBU-61-R/C		SAE J595	6
*LBU-61-B/A		SAE J595	6
*LBU-61-B/C		SAE J595	6
*LBU-61-A/C		SAE J595	6
*LBU-61-A/G		SAE J595	6
*LBU-61-C/M		SAE J595	6
*LBU-61-C/G		SAE J595	6

LBU			
Model	LED Color	Compliance	LED
*LBU-81-R00		SAE J595	8
*LBU-81-B00		SAE J595	8
*LBU-81-A00		SAE J595	8
*LBU-81-C00		SAE J595	8
*LBU-81-G00		SAE J595	8
*LBU-81-M00		SAE J595	8
*LBU-81-R/A		SAE J595	8
*LBU-81-R/B		SAE J595	8
*LBU-81-R/C		SAE J595	8
*LBU-81-B/A		SAE J595	8
*LBU-81-B/C		SAE J595	8
*LBU-81-A/C		SAE J595	8
*LBU-81-A/G		SAE J595	8
*LBU-81-C/M		SAE J595	8
*LBU-81-C/G		SAE J595	8
*LBU-C1-R00		SAE J595	12
*LBU-C1-B00		SAE J595	12
*LBU-C1-A00		SAE J595	12
*LBU-C1-C00		SAE J595	12
*LBU-C1-G00		SAE J595	12
*LBU-C1-M00		SAE J595	12
*LBU-C1-R/A		SAE J595	12
*LBU-C1-R/B		SAE J595	12
*LBU-C1-R/C		SAE J595	12
*LBU-C1-B/A		SAE J595	12
*LBU-C1-B/C		SAE J595	12
*LBU-C1-A/C		SAE J595	12
*LBU-C1-A/G		SAE J595	12
*LBU-C1-C/M		SAE J595	12
*LBU-C1-C/G		SAE J595	12
*LBU-C1-RA0		SAE J595	12
*LBU-C1-RB0		SAE J595	12
*LBU-C1-RC0		SAE J595	12
*LBU-C1-BA0		SAE J595	12
*LBU-C1-BC0		SAE J595	12
*LBU-C1-AC0		SAE J595	12
*LBU-C1-AG0		SAE J595	12
*LBU-C1-CM0		SAE J595	12
*LBU-C1-CG0		SAE J595	12

*Production is contingent upon reaching a specified order quantity.

LBR				LBR			
Model	LED Color	Compliance	LED	Model	LED Color	Compliance	LED
Dome with no optics 				LBR-81-R00  SAE J595 8 *LBR-81-B00  SAE J595 8 *LBR-81-A00  SAE J595 8 *LBR-81-C00  SAE J595 8 *LBR-81-G00  SAE J595 8 *LBR-81-M00  SAE J595 8 *LBR-81-R/A  SAE J595 8 *LBR-81-R/B  SAE J595 8 *LBR-81-R/C  SAE J595 8 *LBR-81-B/A  SAE J595 8 *LBR-81-B/C  SAE J595 8 *LBR-81-A/C  SAE J595 8 *LBR-81-A/G  SAE J595 8 *LBR-81-C/M  SAE J595 8 *LBR-81-C/G  SAE J595 8 *LBR-C1-R00  SAE J595 12 *LBR-C1-B00  SAE J595 12 *LBR-C1-A00  SAE J595 12 *LBR-C1-C00  SAE J595 12 *LBR-C1-G00  SAE J595 12 *LBR-C1-M00  SAE J595 12 *LBR-C1-R/A  SAE J595 12 *LBR-C1-R/B  SAE J595 12 *LBR-C1-R/C  SAE J595 12 *LBR-C1-B/A  SAE J595 12 *LBR-C1-B/C  SAE J595 12 *LBR-C1-A/C  SAE J595 12 *LBR-C1-A/G  SAE J595 12 *LBR-C1-C/M  SAE J595 12 *LBR-C1-C/G  SAE J595 12 *LBR-C1-RA0  SAE J595 12 *LBR-C1-RB0  SAE J595 12 *LBR-C1-RC0  SAE J595 12 *LBR-C1-BA0  SAE J595 12 *LBR-C1-BC0  SAE J595 12 *LBR-C1-AC0  SAE J595 12 *LBR-C1-AG0  SAE J595 12 *LBR-C1-CM0  SAE J595 12 *LBR-C1-CG0  SAE J595 12			
LBR-41-R00		SAE J595	4	LBR-61-R00		SAE J595	6
LBR-41-B00		SAE J595	4	LBR-61-B00		SAE J595	6
LBR-41-A00		SAE J595	4	LBR-61-A00		SAE J595	6
LBR-41-C00		SAE J595	4	LBR-61-C00		SAE J595	6
LBR-41-G00		SAE J595	4	LBR-61-G00		SAE J595	6
LBR-41-M00		SAE J595	4	LBR-61-M00		SAE J595	6
*LBR-41-RA0		SAE J595	4	LBR-61-R/A		SAE J595	6
*LBR-41-RB0		SAE J595	4	LBR-61-R/B		SAE J595	6
*LBR-41-RC0		SAE J595	4	LBR-61-R/C		SAE J595	6
*LBR-41-BA0		SAE J595	4	LBR-61-B/A		SAE J595	6
LBR-41-BC0		SAE J595	4	LBR-61-B/C		SAE J595	6
*LBR-41-AC0		SAE J595	4	LBR-61-A/C		SAE J595	6
*LBR-41-AG0		SAE J595	4	LBR-61-A/G		SAE J595	6
*LBR-41-CM0		SAE J595	4	LBR-61-C/M		SAE J595	6
*LBR-41-CG0		SAE J595	4	LBR-61-C/G		SAE J595	6

*Production is contingent upon reaching a specified order quantity.

HIDE A WAY Series



LHA



LHE



LHF



LHG



LHD



LHP



LHQ



LHR



LHN



LHU

FEATURE

- Ingress Protection Rating: IP67
- Available in Single, Dual and Split
- Input Voltage: 10~30VDC
- Input Current: 1.5A max
- Flash Pattern: 21 (Single), 37 (Dual)
- Ambient Temperature Range: -30~50°C
- Housing: Aluminum
- Accessories: EVA Gasket*1, Screws *2
- Synchronizable up to 8 lights

OPTIONAL ACCESSORIES:

Model	Option Description
R05-LH-01	Rubber Grommet Kits
R01-LH-02	Bezel + Foam + Screw(Black)
R01-LH-04	Bezel + Foam + Screw(Silver)
R02-LH-01	Oval C Bracket Screw Kits
R02-LH-02	Square L Bracket Screw Kits
R02-LH-03	C Bracket Screw Kits



R05-LH-01



R01-LH-02



R01-LH-04



R02-LH-01



R02-LH-02









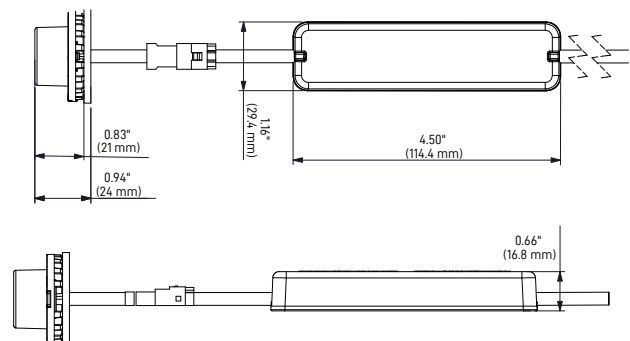
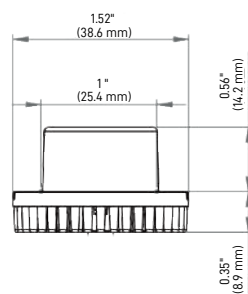
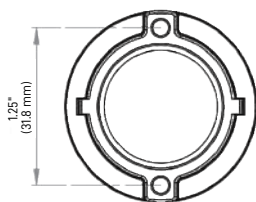

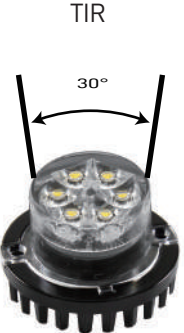
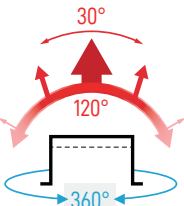





































































R02-LH-03

DIMENSIONS











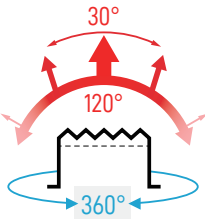





























H0.91" x W1.52" (23.1 x 38.6 mm)









































LHF				
Optics	Model	LED Color	Compliance	LED
 <p>TIR 30°</p>  <p>30° 120° 360°</p>	*LHF-41-R00		SAE J595	4
	*LHF-41-B00		SAE J595	4
	*LHF-41-A00		SAE J595	4
	*LHF-41-C00		SAE J595	4
	*LHF-41-G00		SAE J595	4
	*LHF-41-M00		SAE J595	4
	*LHF-41-R/A		SAE J595	4
	*LHF-41-R/B		SAE J595	4
	*LHF-41-R/C		SAE J595	4
	*LHF-41-B/A		SAE J595	4
	*LHF-41-B/C		SAE J595	4
	*LHF-41-A/C		SAE J595	4
	*LHF-41-A/G		SAE J595	4
	*LHF-41-C/M		SAE J595	4
	*LHF-41-C/G		SAE J595	4
	*LHF-41-RA0		SAE J595	4
	*LHF-41-RB0		SAE J595	4
	*LHF-41-RC0		SAE J595	4
	*LHF-41-BA0		SAE J595	4
	*LHF-41-BC0		SAE J595	4
	*LHF-41-AC0		SAE J595	4
	*LHF-41-AG0		SAE J595	4
	*LHF-41-CM0		SAE J595	4
	*LHF-41-CG0		SAE J595	4
	*LHF-42-R00		SAE J595	8
	*LHF-42-B00		SAE J595	8
	*LHF-42-A00		SAE J595	8
	*LHF-42-C00		SAE J595	8
	*LHF-42-G00		SAE J595	8
	*LHF-42-M00		SAE J595	8
	*LHF-42-R/A		SAE J595	8
	*LHF-42-R/B		SAE J595	8
*LHF-42-R/C		SAE J595	8	
*LHF-42-B/A		SAE J595	8	
*LHF-42-B/C		SAE J595	8	
*LHF-42-A/C		SAE J595	8	
*LHF-42-A/G		SAE J595	8	
*LHF-42-C/M		SAE J595	8	
*LHF-42-C/G		SAE J595	8	

LHF			
Model	LED Color	Compliance	LED
*LHF-61-R00		SAE J595	6
*LHF-61-B00		SAE J595	6
*LHF-61-A00		SAE J595	6
*LHF-61-C00		SAE J595	6
*LHF-61-G00		SAE J595	6
*LHF-61-M00		SAE J595	6
*LHF-61-R/A		SAE J595	6
*LHF-61-R/B		SAE J595	6
*LHF-61-R/C		SAE J595	6
*LHF-61-B/A		SAE J595	6
*LHF-61-B/C		SAE J595	6
*LHF-61-A/C		SAE J595	6
*LHF-61-A/G		SAE J595	6
*LHF-61-C/M		SAE J595	6
*LHF-61-C/G		SAE J595	6
*LHF-61-RA0		SAE J595	6
*LHF-61-RB0		SAE J595	6
*LHF-61-RC0		SAE J595	6
*LHF-61-BA0		SAE J595	6
*LHF-61-BC0		SAE J595	6
*LHF-61-AC0		SAE J595	6
*LHF-61-AG0		SAE J595	6
*LHF-61-CM0		SAE J595	6
*LHF-61-CG0		SAE J595	6
*LHF-62-R00		SAE J595	12
*LHF-62-B00		SAE J595	12
LHF-62-A00		SAE J595	12
LHF-62-C00		SAE J595	12
*LHF-62-G00		SAE J595	12
*LHF-62-M00		SAE J595	12
*LHF-62-R/A		SAE J595	12
*LHF-62-R/B		SAE J595	12
*LHF-62-R/C		SAE J595	12
*LHF-62-B/A		SAE J595	12
LHF-62-B/C		SAE J595	12
LHF-62-A/C		SAE J595	12
*LHF-62-A/G		SAE J595	12
*LHF-62-C/M		SAE J595	12
*LHF-62-C/G		SAE J595	12

*Production is contingent upon reaching a specified order quantity.

LHE				
Optics	Model	LED Color	Compliance	LED
<p>TIR+Diffuser</p>  	LHE-41-R00		SAE J595	4
	LHE-41-B00		SAE J595, ECE R10, ECE R65 Class 1	4
	LHE-41-A00		SAE J595, ECE R10, ECE R65 Class 1	4
	LHE-41-C00		SAE J595	4
	*LHE-41-G00		SAE J595	4
	*LHE-41-M00		SAE J595	4
	*LHE-41-RA0		SAE J595	4
	*LHE-41-RB0		SAE J595	4
	*LHE-41-RC0		SAE J595	4
	*LHE-41-BA0		SAE J595	4
	*LHE-41-BC0		SAE J595	4
	LHE-41-AC0		SAE J595	4
	*LHE-41-AG0		SAE J595	4
	*LHE-41-CM0		SAE J595	4
	*LHE-41-CG0		SAE J595	4
	LHE-42-R00		SAE J595	8
	LHE-42-B00		SAE J595	8
	LHE-42-A00		SAE J595	8
	LHE-42-C00		SAE J595	8
	LHE-42-G00		SAE J595	8
	*LHE-42-M00		SAE J595	8
	*LHE-42-R/A		SAE J595	8
	LHE-42-R/B		SAE J595	8
	*LHE-42-R/C		SAE J595	8
	*LHE-42-B/A		SAE J595	8
	*LHE-42-B/C		SAE J595	8
	*LHE-42-A/C		SAE J595	8
	*LHE-42-A/G		SAE J595	8
	*LHE-42-C/M		SAE J595	8
	*LHE-42-C/G		SAE J595	8
	*LHE-42-RA0		SAE J595	8
	LHE-42-RB0		SAE J595	8
	LHE-42-RC0		SAE J595	8
	LHE-42-BA0		SAE J595	8
	LHE-42-BC0		SAE J595	8
	*LHE-42-AC0		SAE J595	8
*LHE-42-AG0		SAE J595	8	
*LHE-42-CM0		SAE J595	8	
*LHE-42-CG0		SAE J595	8	

LHE			
Model	LED Color	Compliance	LED
LHE-61-R00		SAE J595	6
*LHE-61-B00		SAE J595	6
LHE-61-A00		SAE J595	6
LHE-61-C00		SAE J595	6
*LHE-61-G00		SAE J595	6
*LHE-61-M00		SAE J595	6
*LHE-61-R/A		SAE J595	6
LHE-61-R/B		SAE J595	6
*LHE-61-R/C		SAE J595	6
*LHE-61-B/A		SAE J595	6
*LHE-61-B/C		SAE J595	6
LHE-61-A/C		SAE J595	6
*LHE-61-A/G		SAE J595	6
*LHE-61-C/M		SAE J595	6
*LHE-61-C/G		SAE J595	6
*LHE-62-R00		SAE J595	12
*LHE-62-B00		SAE J595	12
*LHE-62-A00		SAE J595	12
LHE-62-C00		SAE J595	12
*LHE-62-G00		SAE J595	12
*LHE-62-M00		SAE J595	12
*LHE-62-R/A		SAE J595	12
*LHE-62-R/B		SAE J595	12
*LHE-62-R/C		SAE J595	12
*LHE-62-B/A		SAE J595	12
*LHE-62-B/C		SAE J595	12
LHE-62-A/C		SAE J595	12
*LHE-62-A/G		SAE J595	12
*LHE-62-C/M		SAE J595	12
*LHE-62-C/G		SAE J595	12
*LHE-62-RA0		SAE J595	12
LHE-62-RB0		SAE J595	12
*LHE-62-RC0		SAE J595	12
*LHE-62-BA0		SAE J595	12
*LHE-62-BC0		SAE J595	12
*LHE-62-AC0		SAE J595	12
*LHE-62-AG0		SAE J595	12
*LHE-62-CM0		SAE J595	12
*LHE-62-CG0		SAE J595	12

*Production is contingent upon reaching a specified order quantity.

LHD				
Optics	Model	LED Color	Compliance	LED
E+Flat cover	LHD-41-R00	●	SAE J595	4
	LHD-41-B00	●	SAE J595, ECE R10, ECE R65 Class 1	4
	LHD-41-A00	●	SAE J595, ECE R10, ECE R65 Class 1	4
	LHD-41-C00	●	SAE J595	4
	LHD-41-G00	●	SAE J595	4
	*LHD-41-M00	●	SAE J595	4
	*LHD-41-RA0	●	SAE J595	4
	*LHD-41-RB0	●	SAE J595	4
	*LHD-41-RC0	●	SAE J595	4
	*LHD-41-BA0	●	SAE J595	4
	*LHD-41-BC0	●	SAE J595	4
	*LHD-41-AC0	●	SAE J595	4
	*LHD-41-AG0	●	SAE J595	4
	*LHD-41-CM0	●	SAE J595	4
	*LHD-41-CG0	●	SAE J595	4
	LHD-42-R00	●	SAE J595	8
	LHD-42-B00	●	SAE J595	8
	LHD-42-A00	●	SAE J595	8
	LHD-42-C00	●	SAE J595	8
	LHD-42-G00	●	SAE J595	8
	*LHD-42-M00	●	SAE J595	8
	*LHD-42-R/A	●	SAE J595	8
	*LHD-42-R/B	●	SAE J595	8
	*LHD-42-R/C	●	SAE J595	8
	*LHD-42-B/A	●	SAE J595	8
	*LHD-42-B/C	●	SAE J595	8
	*LHD-42-A/C	●	SAE J595	8
	*LHD-42-A/G	●	SAE J595	8
	*LHD-42-C/M	●	SAE J595	8
	*LHD-42-C/G	●	SAE J595	8
	LHD-42-RA0	●	SAE J595	8
	LHD-42-RB0	●	SAE J595	8
	*LHD-42-RC0	●	SAE J595	8
	LHD-42-BA0	●	SAE J595	8
	LHD-42-BC0	●	SAE J595	8
	*LHD-42-AC0	●	SAE J595	8
*LHD-42-AG0	●	SAE J595	8	
*LHD-42-CM0	●	SAE J595	8	
*LHD-42-CG0	●	SAE J595	8	

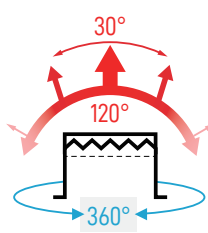

LHD			
Model	LED Color	Compliance	LED
*LHD-61-R00	●	SAE J595	6
*LHD-61-B00	●	SAE J595	6
LHD-61-A00	●	SAE J595	6
*LHD-61-C00	●	SAE J595	6
*LHD-61-G00	●	SAE J595	6
*LHD-61-M00	●	SAE J595	6
*LHD-61-R/A	●	SAE J595	6
*LHD-61-R/B	●	SAE J595	6
*LHD-61-R/C	●	SAE J595	6
*LHD-61-B/A	●	SAE J595	6
*LHD-61-B/C	●	SAE J595	6
*LHD-61-A/C	●	SAE J595	6
*LHD-61-A/G	●	SAE J595	6
*LHD-61-C/M	●	SAE J595	6
*LHD-61-C/G	●	SAE J595	6
*LHD-62-R00	●	SAE J595	12
*LHD-62-B00	●	SAE J595	12
*LHD-62-A00	●	SAE J595	12
*LHD-62-C00	●	SAE J595	12
*LHD-62-G00	●	SAE J595	12
*LHD-62-M00	●	SAE J595	12
*LHD-62-R/A	●	SAE J595	12
*LHD-62-R/B	●	SAE J595	12
*LHD-62-R/C	●	SAE J595	12
*LHD-62-B/A	●	SAE J595	12
*LHD-62-B/C	●	SAE J595	12
*LHD-62-A/C	●	SAE J595	12
*LHD-62-A/G	●	SAE J595	12
*LHD-62-C/M	●	SAE J595	12
*LHD-62-C/G	●	SAE J595	12
*LHD-62-RA0	●	SAE J595	12
*LHD-62-RB0	●	SAE J595	12
*LHD-62-RC0	●	SAE J595	12
*LHD-62-BA0	●	SAE J595	12
*LHD-62-BC0	●	SAE J595	12
*LHD-62-AC0	●	SAE J595	12
*LHD-62-AG0	●	SAE J595	12
*LHD-62-CM0	●	SAE J595	12
*LHD-62-CG0	●	SAE J595	12



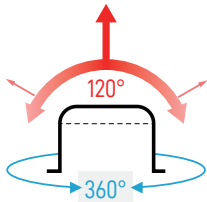







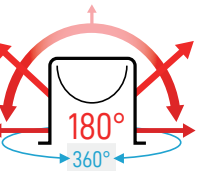











































*Production is contingent upon reaching a specified order quantity.

LHG					LHG					LHG				
Optics	Model	LED Color	Compliance	LED	Model	LED Color	Compliance	LED	Model	LED Color	Compliance	LED		
Super slim dome  	*LHG-41-R00	●	SAE J595	4	LHG-61-R00	●	SAE J595	6	LHG-81-R00	●	SAE J595	8		
	*LHG-41-B00	●	SAE J595	4	LHG-61-B00	●	SAE J595	6	LHG-81-B00	●	SAE J595	8		
	*LHG-41-A00	●	SAE J595	4	LHG-61-A00	●	SAE J595	6	LHG-81-A00	●	SAE J595	8		
	*LHG-41-C00	○	SAE J595	4	LHG-61-C00	○	SAE J595	6	LHG-81-C00	○	SAE J595	8		
	*LHG-41-G00	●	SAE J595	4	LHG-61-G00	●	SAE J595	6	LHG-81-G00	●	SAE J595	8		
	*LHG-41-M00	●	SAE J595	4	LHG-61-M00	●	SAE J595	6	LHG-81-M00	●	SAE J595	8		
	*LHG-41-RA0	●	SAE J595	4	LHG-61-R/A	●	SAE J595	6	LHG-81-R/A	●	SAE J595	8		
	*LHG-41-RB0	●	SAE J595	4	LHG-61-R/B	●	SAE J595	6	LHG-81-R/B	●	SAE J595	8		
	*LHG-41-RC0	●	SAE J595	4	LHG-61-R/C	●	SAE J595	6	LHG-81-R/C	●	SAE J595	8		
	*LHG-41-BA0	●	SAE J595	4	LHG-61-B/A	●	SAE J595	6	LHG-81-B/A	●	SAE J595	8		
	*LHG-41-BC0	●	SAE J595	4	LHG-61-B/C	●	SAE J595	6	LHG-81-B/C	●	SAE J595	8		
	*LHG-41-AC0	●	SAE J595	4	LHG-61-A/C	●	SAE J595	6	LHG-81-A/C	●	SAE J595	8		
	*LHG-41-AG0	●	SAE J595	4	LHG-61-A/G	●	SAE J595	6	LHG-81-A/G	●	SAE J595	8		
	*LHG-41-CM0	●	SAE J595	4	LHG-61-C/M	●	SAE J595	6	LHG-81-C/M	●	SAE J595	8		
	*LHG-41-CG0	●	SAE J595	4	LHG-61-C/G	●	SAE J595	6	LHG-81-C/G	●	SAE J595	8		
	LHG-42-R00	●	SAE J595	8	*LHG-62-R00	●	SAE J595	12	LHG-C1-R00	●	SAE J595	12		
	LHG-42-B00	●	SAE J595	8	*LHG-62-B00	●	SAE J595	12	LHG-C1-B00	●	SAE J595	12		
	LHG-42-A00	●	SAE J595	8	*LHG-62-A00	●	SAE J595	12	LHG-C1-A00	●	SAE J595	12		
	LHG-42-C00	○	SAE J595	8	*LHG-62-C00	○	SAE J595	12	LHG-C1-C00	○	SAE J595	12		
	*LHG-42-G00	●	SAE J595	8	*LHG-62-G00	●	SAE J595	12	LHG-C1-G00	●	SAE J595	12		
	*LHG-42-M00	●	SAE J595	8	*LHG-62-M00	●	SAE J595	12	LHG-C1-M00	●	SAE J595	12		
	*LHG-42-R/A	●	SAE J595	8	*LHG-62-R/A	●	SAE J595	12	LHG-C1-R/A	●	SAE J595	12		
	*LHG-42-R/B	●	SAE J595	8	*LHG-62-R/B	●	SAE J595	12	LHG-C1-R/B	●	SAE J595	12		
	*LHG-42-R/C	●	SAE J595	8	*LHG-62-R/C	●	SAE J595	12	LHG-C1-R/C	●	SAE J595	12		
	*LHG-42-B/A	●	SAE J595	8	*LHG-62-B/A	●	SAE J595	12	LHG-C1-B/A	●	SAE J595	12		
	*LHG-42-B/C	●	SAE J595	8	*LHG-62-B/C	●	SAE J595	12	LHG-C1-B/C	●	SAE J595	12		
	*LHG-42-A/C	●	SAE J595	8	*LHG-62-A/C	●	SAE J595	12	LHG-C1-A/C	●	SAE J595	12		
	*LHG-42-A/G	●	SAE J595	8	*LHG-62-A/G	●	SAE J595	12	LHG-C1-A/G	●	SAE J595	12		
	*LHG-42-C/M	●	SAE J595	8	*LHG-62-C/M	●	SAE J595	12	*LHG-C1-C/M	●	SAE J595	12		
	*LHG-42-C/G	●	SAE J595	8	*LHG-62-C/G	●	SAE J595	12	LHG-C1-C/G	●	SAE J595	12		
	*LHG-42-RA0	●	SAE J595	8	*LHG-62-RA0	●	SAE J595	12	LHG-C1-RA0	●	SAE J595	12		
	*LHG-42-RB0	●	SAE J595	8	*LHG-62-RB0	●	SAE J595	12	LHG-C1-RB0	●	SAE J595	12		
	*LHG-42-RC0	●	SAE J595	8	*LHG-62-RC0	●	SAE J595	12	LHG-C1-RC0	●	SAE J595	12		
	LHG-42-BA0	●	SAE J595	8	*LHG-62-BA0	●	SAE J595	12	LHG-C1-BA0	●	SAE J595	12		
	*LHG-42-BC0	●	SAE J595	8	*LHG-62-BC0	●	SAE J595	12	LHG-C1-BC0	●	SAE J595	12		
	LHG-42-AC0	●	SAE J595	8	*LHG-62-AC0	●	SAE J595	12	LHG-C1-AC0	●	SAE J595	12		
	*LHG-42-AG0	●	SAE J595	8	*LHG-62-AG0	●	SAE J595	12	LHG-C1-AG0	●	SAE J595	12		
	*LHG-42-CM0	●	SAE J595	8	*LHG-62-CM0	●	SAE J595	12	LHG-C1-CM0	●	SAE J595	12		
	*LHG-42-CG0	●	SAE J595	8	*LHG-62-CG0	●	SAE J595	12	LHG-C1-CG0	●	SAE J595	12		











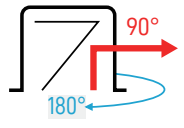





*Production is contingent upon reaching a specified order quantity.

LHP

LHP

Optics	Model	LED Color	Compliance	LED	Model	LED Color	Compliance	LED
 <p>Cylinder with 360°</p>  <p>Cylinder with 90°</p>	LHP-61-R00		SAE J595, ECE R10	6	*LHP-81-R00		SAE J595	8
	LHP-61-B00		SAE J595, ECE R10	6	*LHP-81-B00		SAE J595	8
	LHP-61-A00		SAE J595, ECE R10	6	*LHP-81-A00		SAE J595	8
	LHP-61-C00		SAE J595, ECE R10	6	*LHP-81-C00		SAE J595	8
	LHP-61-G00		SAE J595, ECE R10	6	*LHP-81-G00		SAE J595	8
	LHP-61-M00		SAE J595, ECE R10	6	*LHP-81-M00		SAE J595	8
	LHP-61-R/A		SAE J595, ECE R10	6	*LHP-81-R/A		SAE J595	8
	LHP-61-R/B		SAE J595, ECE R10	6	*LHP-81-R/B		SAE J595	8
	LHP-61-R/C		SAE J595, ECE R10	6	*LHP-81-R/C		SAE J595	8
	LHP-61-B/A		SAE J595, ECE R10	6	*LHP-81-B/A		SAE J595	8
	LHP-61-B/C		SAE J595, ECE R10	6	*LHP-81-B/C		SAE J595	8
	LHP-61-A/C		SAE J595, ECE R10	6	*LHP-81-A/C		SAE J595	8
	LHP-61-A/G		SAE J595, ECE R10	6	*LHP-81-A/G		SAE J595	8
	LHP-61-C/M		SAE J595, ECE R10	6	*LHP-81-C/M		SAE J595	8
	LHP-61-C/G		SAE J595, ECE R10	6	*LHP-81-C/G		SAE J595	8
	LHP-62-R00		SAE J595	12				
	LHP-62-B00		SAE J595	12				
	LHP-62-A00		SAE J595	12				
	LHP-62-C00		SAE J595	12				
	*LHP-62-G00		SAE J595	12				
	LHP-62-M00		SAE J595	12				
	*LHP-62-R/A		SAE J595	12				
	*LHP-62-R/B		SAE J595	12				
	*LHP-62-R/C		SAE J595	12				
	*LHP-62-B/A		SAE J595	12				
	*LHP-62-B/C		SAE J595	12				
	*LHP-62-A/C		SAE J595	12				
	*LHP-62-A/G		SAE J595	12				
*LHP-62-C/M		SAE J595	12					
*LHP-62-C/G		SAE J595	12					
*LHP-62-RA0		SAE J595	12					
*LHP-62-RB0		SAE J595	12					
*LHP-62-RC0		SAE J595	12					
*LHP-62-BA0		SAE J595	12					
*LHP-62-BC0		SAE J595	12					
*LHP-62-AC0		SAE J595	12					
*LHP-62-AG0		SAE J595	12					
*LHP-62-CM0		SAE J595	12					
*LHP-62-CG0		SAE J595	12					

LHA

Optics	Model	LED Color	Compliance	LED
 <p>Cylinder with 90°</p> 	LHA-41-R00		SAE J595	4
	*LHA-41-B00		SAE J595	4
	*LHA-41-A00		SAE J595	4
	*LHA-41-C00		SAE J595	4
	*LHA-41-G00		SAE J595	4
	*LHA-41-M00		SAE J595	4
	*LHA-41-RA0		SAE J595	4
	LHA-41-RB0		SAE J595	4
	LHA-41-RC0		SAE J595	4
	*LHA-41-BA0		SAE J595	4
	LHA-41-BC0		SAE J595	4
	*LHA-41-AC0		SAE J595	4
	*LHA-41-AG0		SAE J595	4
	*LHA-41-CM0		SAE J595	4
	*LHA-41-CG0		SAE J595	4

*Production is contingent upon reaching a specified order quantity.

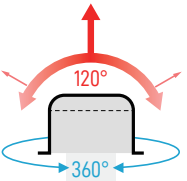
LHQ					LHQ					LHQ				
Optics	Model	LED Color	Compliance	LED	Model	LED Color	Compliance	LED	Model	LED Color	Compliance	LED		
Matte+G  	*LHQ-41-R00	●	SAE J595	4	*LHQ-61-R00	●	SAE J595	6	*LHQ-81-R00	●	SAE J595	8		
	*LHQ-41-B00	●	SAE J595	4	*LHQ-61-B00	●	SAE J595	6	*LHQ-81-B00	●	SAE J595	8		
	*LHQ-41-A00	●	SAE J595	4	*LHQ-61-A00	●	SAE J595	6	*LHQ-81-A00	●	SAE J595	8		
	*LHQ-41-C00	●	SAE J595	4	*LHQ-61-C00	●	SAE J595	6	*LHQ-81-C00	●	SAE J595	8		
	*LHQ-41-G00	●	SAE J595	4	*LHQ-61-G00	●	SAE J595	6	*LHQ-81-G00	●	SAE J595	8		
	*LHQ-41-M00	●	SAE J595	4	*LHQ-61-M00	●	SAE J595	6	*LHQ-81-M00	●	SAE J595	8		
	*LHQ-41-RA0	●	SAE J595	4	*LHQ-61-R/A	●	SAE J595	6	*LHQ-81-R/A	●	SAE J595	8		
	*LHQ-41-RB0	●	SAE J595	4	*LHQ-61-R/B	●	SAE J595	6	*LHQ-81-R/B	●	SAE J595	8		
	*LHQ-41-RC0	●	SAE J595	4	*LHQ-61-R/C	●	SAE J595	6	*LHQ-81-R/C	●	SAE J595	8		
	*LHQ-41-BA0	●	SAE J595	4	*LHQ-61-B/A	●	SAE J595	6	*LHQ-81-B/A	●	SAE J595	8		
	*LHQ-41-BC0	●	SAE J595	4	*LHQ-61-B/C	●	SAE J595	6	*LHQ-81-B/C	●	SAE J595	8		
	*LHQ-41-AC0	●	SAE J595	4	*LHQ-61-A/C	●	SAE J595	6	*LHQ-81-A/C	●	SAE J595	8		
	*LHQ-41-AG0	●	SAE J595	4	*LHQ-61-A/G	●	SAE J595	6	*LHQ-81-A/G	●	SAE J595	8		
	*LHQ-41-CM0	●	SAE J595	4	*LHQ-61-C/M	●	SAE J595	6	*LHQ-81-C/M	●	SAE J595	8		
	*LHQ-41-CG0	●	SAE J595	4	*LHQ-61-C/G	●	SAE J595	6	*LHQ-81-C/G	●	SAE J595	8		
	*LHQ-42-R00	●	SAE J595	8	*LHQ-62-R00	●	SAE J595	12	*LHQ-C1-R00	●	SAE J595	12		
	*LHQ-42-B00	●	SAE J595	8	*LHQ-62-B00	●	SAE J595	12	*LHQ-C1-B00	●	SAE J595	12		
	*LHQ-42-A00	●	SAE J595	8	*LHQ-62-A00	●	SAE J595	12	*LHQ-C1-A00	●	SAE J595	12		
	*LHQ-42-C00	●	SAE J595	8	*LHQ-62-C00	●	SAE J595	12	*LHQ-C1-C00	●	SAE J595	12		
	*LHQ-42-G00	●	SAE J595	8	*LHQ-62-G00	●	SAE J595	12	*LHQ-C1-G00	●	SAE J595	12		
	*LHQ-42-M00	●	SAE J595	8	*LHQ-62-M00	●	SAE J595	12	*LHQ-C1-M00	●	SAE J595	12		
	*LHQ-42-R/A	●	SAE J595	8	*LHQ-62-R/A	●	SAE J595	12	*LHQ-C1-R/A	●	SAE J595	12		
	*LHQ-42-R/B	●	SAE J595	8	*LHQ-62-R/B	●	SAE J595	12	*LHQ-C1-R/B	●	SAE J595	12		
	*LHQ-42-R/C	●	SAE J595	8	*LHQ-62-R/C	●	SAE J595	12	*LHQ-C1-R/C	●	SAE J595	12		
	*LHQ-42-B/A	●	SAE J595	8	*LHQ-62-B/A	●	SAE J595	12	*LHQ-C1-B/A	●	SAE J595	12		
	*LHQ-42-B/C	●	SAE J595	8	*LHQ-62-B/C	●	SAE J595	12	*LHQ-C1-B/C	●	SAE J595	12		
	*LHQ-42-A/C	●	SAE J595	8	*LHQ-62-A/C	●	SAE J595	12	*LHQ-C1-A/C	●	SAE J595	12		
	*LHQ-42-A/G	●	SAE J595	8	*LHQ-62-A/G	●	SAE J595	12	*LHQ-C1-A/G	●	SAE J595	12		
	*LHQ-42-C/M	●	SAE J595	8	*LHQ-62-C/M	●	SAE J595	12	*LHQ-C1-C/M	●	SAE J595	12		
	*LHQ-42-C/G	●	SAE J595	8	*LHQ-62-C/G	●	SAE J595	12	*LHQ-C1-C/G	●	SAE J595	12		
	*LHQ-42-RA0	●	SAE J595	8	*LHQ-62-RA0	●	SAE J595	12	*LHQ-C1-RA0	●	SAE J595	12		
	*LHQ-42-RB0	●	SAE J595	8	*LHQ-62-RB0	●	SAE J595	12	*LHQ-C1-RB0	●	SAE J595	12		
	*LHQ-42-RC0	●	SAE J595	8	*LHQ-62-RC0	●	SAE J595	12	*LHQ-C1-RC0	●	SAE J595	12		
	*LHQ-42-BA0	●	SAE J595	8	*LHQ-62-BA0	●	SAE J595	12	*LHQ-C1-BA0	●	SAE J595	12		
	*LHQ-42-BC0	●	SAE J595	8	*LHQ-62-BC0	●	SAE J595	12	*LHQ-C1-BC0	●	SAE J595	12		
	*LHQ-42-AC0	●	SAE J595	8	*LHQ-62-AC0	●	SAE J595	12	*LHQ-C1-AC0	●	SAE J595	12		
	*LHQ-42-AG0	●	SAE J595	8	*LHQ-62-AG0	●	SAE J595	12	*LHQ-C1-AG0	●	SAE J595	12		
	*LHQ-42-CM0	●	SAE J595	8	*LHQ-62-CM0	●	SAE J595	12	*LHQ-C1-CM0	●	SAE J595	12		
	*LHQ-42-CG0	●	SAE J595	8	*LHQ-62-CG0	●	SAE J595	12	*LHQ-C1-CG0	●	SAE J595	12		

*Production is contingent upon reaching a specified order quantity.

LHN					LHN					LHN				
Optics	Model	LED Color	Compliance	LED	Model	LED Color	Compliance	LED	Model	LED Color	Compliance	LED		
Navel with no optics  	*LHN-41-R00	●	SAE J595	4	LHN-61-R00	●	SAE J595	6	*LHN-81-R00	●	SAE J595	8		
	*LHN-41-B00	●	SAE J595	4	LHN-61-B00	●	SAE J595	6	*LHN-81-B00	●	SAE J595	8		
	*LHN-41-A00	●	SAE J595	4	LHN-61-A00	●	SAE J595	6	*LHN-81-A00	●	SAE J595	8		
	*LHN-41-C00	○	SAE J595	4	LHN-61-C00	○	SAE J595	6	LHN-81-C00	○	SAE J595	8		
	*LHN-41-G00	●	SAE J595	4	*LHN-61-G00	●	SAE J595	6	*LHN-81-G00	●	SAE J595	8		
	*LHN-41-M00	●	SAE J595	4	*LHN-61-M00	●	SAE J595	6	*LHN-81-M00	●	SAE J595	8		
	*LHN-41-RA0	●	SAE J595	4	*LHN-61-R/A	●	SAE J595	6	*LHN-81-R/A	●	SAE J595	8		
	*LHN-41-RB0	●	SAE J595	4	LHN-61-R/B	●	SAE J595	6	*LHN-81-R/B	●	SAE J595	8		
	*LHN-41-RC0	○	SAE J595	4	LHN-61-R/C	○	SAE J595	6	*LHN-81-R/C	○	SAE J595	8		
	*LHN-41-BA0	●	SAE J595	4	*LHN-61-B/A	●	SAE J595	6	*LHN-81-B/A	●	SAE J595	8		
	*LHN-41-BC0	○	SAE J595	4	LHN-61-B/C	○	SAE J595	6	*LHN-81-B/C	○	SAE J595	8		
	*LHN-41-AC0	○	SAE J595	4	LHN-61-A/C	○	SAE J595	6	*LHN-81-A/C	○	SAE J595	8		
	*LHN-41-AG0	●	SAE J595	4	*LHN-61-A/G	●	SAE J595	6	*LHN-81-A/G	●	SAE J595	8		
	*LHN-41-CM0	○	SAE J595	4	*LHN-61-C/M	○	SAE J595	6	*LHN-81-C/M	○	SAE J595	8		
	*LHN-41-CG0	○	SAE J595	4	*LHN-61-C/G	○	SAE J595	6	*LHN-81-C/G	○	SAE J595	8		
	*LHN-42-R00	●	SAE J595	8	*LHN-62-R00	●	SAE J595	12	LHN-C1-R00	●	SAE J595	12		
	*LHN-42-B00	●	SAE J595	8	*LHN-62-B00	●	SAE J595	12	LHN-C1-B00	●	SAE J595	12		
	*LHN-42-A00	●	SAE J595	8	LHN-62-A00	●	SAE J595	12	LHN-C1-A00	●	SAE J595	12		
	*LHN-42-C00	○	SAE J595	8	*LHN-62-C00	○	SAE J595	12	LHN-C1-C00	○	SAE J595	12		
	*LHN-42-G00	●	SAE J595	8	*LHN-62-G00	●	SAE J595	12	LHN-C1-G00	●	SAE J595	12		
	*LHN-42-M00	●	SAE J595	8	*LHN-62-M00	●	SAE J595	12	*LHN-C1-M00	●	SAE J595	12		
	*LHN-42-R/A	●	SAE J595	8	*LHN-62-R/A	●	SAE J595	12	*LHN-C1-R/A	●	SAE J595	12		
	*LHN-42-R/B	●	SAE J595	8	*LHN-62-R/B	●	SAE J595	12	*LHN-C1-R/B	●	SAE J595	12		
	*LHN-42-R/C	○	SAE J595	8	*LHN-62-R/C	○	SAE J595	12	*LHN-C1-R/C	○	SAE J595	12		
	*LHN-42-B/A	●	SAE J595	8	*LHN-62-B/A	●	SAE J595	12	*LHN-C1-B/A	●	SAE J595	12		
	*LHN-42-B/C	○	SAE J595	8	*LHN-62-B/C	○	SAE J595	12	*LHN-C1-B/C	○	SAE J595	12		
	*LHN-42-A/C	○	SAE J595	8	*LHN-62-A/C	○	SAE J595	12	LHN-C1-A/C	○	SAE J595	12		
	*LHN-42-A/G	●	SAE J595	8	*LHN-62-A/G	●	SAE J595	12	*LHN-C1-A/G	●	SAE J595	12		
	*LHN-42-C/M	○	SAE J595	8	*LHN-62-C/M	○	SAE J595	12	*LHN-C1-C/M	○	SAE J595	12		
	*LHN-42-C/G	○	SAE J595	8	*LHN-62-C/G	○	SAE J595	12	*LHN-C1-C/G	○	SAE J595	12		
	*LHN-42-RA0	●	SAE J595	8	*LHN-62-RA0	●	SAE J595	12	LHN-C1-RA0	●	SAE J595	12		
	*LHN-42-RB0	●	SAE J595	8	LHN-62-RB0	●	SAE J595	12	LHN-C1-RB0	●	SAE J595	12		
	*LHN-42-RC0	○	SAE J595	8	*LHN-62-RC0	○	SAE J595	12	LHN-C1-RC0	○	SAE J595	12		
	*LHN-42-BA0	●	SAE J595	8	*LHN-62-BA0	●	SAE J595	12	LHN-C1-BA0	●	SAE J595	12		
	*LHN-42-BC0	○	SAE J595	8	*LHN-62-BC0	○	SAE J595	12	LHN-C1-BC0	○	SAE J595	12		
	*LHN-42-AC0	○	SAE J595	8	*LHN-62-AC0	○	SAE J595	12	LHN-C1-AC0	○	SAE J595	12		
	*LHN-42-AG0	●	SAE J595	8	*LHN-62-AG0	●	SAE J595	12	*LHN-C1-AG0	●	SAE J595	12		
	*LHN-42-CM0	○	SAE J595	8	*LHN-62-CM0	○	SAE J595	12	*LHN-C1-CM0	○	SAE J595	12		
	*LHN-42-CG0	○	SAE J595	8	*LHN-62-CG0	○	SAE J595	12	LHN-C1-CG0	○	SAE J595	12		

*Production is contingent upon reaching a specified order quantity.

LHU					LHU					LHU				
Optics	Model	LED Color	Compliance	LED	Model	LED Color	Compliance	LED	Model	LED Color	Compliance	LED		
Matte+N	*LHU-41-R00	●	SAE J595	4	*LHU-61-R00	●	SAE J595	6	*LHU-81-R00	●	SAE J595	8		
	*LHU-41-B00	●	SAE J595	4	*LHU-61-B00	●	SAE J595	6	*LHU-81-B00	●	SAE J595	8		
	*LHU-41-A00	●	SAE J595	4	*LHU-61-A00	●	SAE J595	6	*LHU-81-A00	●	SAE J595	8		
	*LHU-41-C00	●	SAE J595	4	*LHU-61-C00	●	SAE J595	6	*LHU-81-C00	●	SAE J595	8		
	*LHU-41-G00	●	SAE J595	4	*LHU-61-G00	●	SAE J595	6	*LHU-81-G00	●	SAE J595	8		
	*LHU-41-M00	●	SAE J595	4	*LHU-61-M00	●	SAE J595	6	*LHU-81-M00	●	SAE J595	8		
	*LHU-41-RA0	●	SAE J595	4	*LHU-61-R/A	●	SAE J595	6	*LHU-81-R/A	●	SAE J595	8		
	*LHU-41-RB0	●	SAE J595	4	*LHU-61-R/B	●	SAE J595	6	*LHU-81-R/B	●	SAE J595	8		
	*LHU-41-RC0	●	SAE J595	4	*LHU-61-R/C	●	SAE J595	6	*LHU-81-R/C	●	SAE J595	8		
	*LHU-41-BA0	●	SAE J595	4	*LHU-61-B/A	●	SAE J595	6	*LHU-81-B/A	●	SAE J595	8		
	*LHU-41-BC0	●	SAE J595	4	*LHU-61-B/C	●	SAE J595	6	*LHU-81-B/C	●	SAE J595	8		
	*LHU-41-AC0	●	SAE J595	4	LHU-61-A/C	●	SAE J595	6	*LHU-81-A/C	●	SAE J595	8		
	*LHU-41-AG0	●	SAE J595	4	*LHU-61-A/G	●	SAE J595	6	*LHU-81-A/G	●	SAE J595	8		
	*LHU-41-CM0	●	SAE J595	4	*LHU-61-C/M	●	SAE J595	6	*LHU-81-C/M	●	SAE J595	8		
	*LHU-41-CG0	●	SAE J595	4	*LHU-61-C/G	●	SAE J595	6	*LHU-81-C/G	●	SAE J595	8		
	*LHU-42-R00	●	SAE J595	8	*LHU-62-R00	●	SAE J595	12	LHU-C1-R00	●	SAE J595	12		
	*LHU-42-B00	●	SAE J595	8	*LHU-62-B00	●	SAE J595	12	LHU-C1-B00	●	SAE J595	12		
	*LHU-42-A00	●	SAE J595	8	*LHU-62-A00	●	SAE J595	12	LHU-C1-A00	●	SAE J595	12		
	*LHU-42-C00	●	SAE J595	8	*LHU-62-C00	●	SAE J595	12	LHU-C1-C00	●	SAE J595	12		
	*LHU-42-G00	●	SAE J595	8	*LHU-62-G00	●	SAE J595	12	LHU-C1-G00	●	SAE J595	12		
	*LHU-42-M00	●	SAE J595	8	*LHU-62-M00	●	SAE J595	12	*LHU-C1-M00	●	SAE J595	12		
	*LHU-42-R/A	●	SAE J595	8	*LHU-62-R/A	●	SAE J595	12	*LHU-C1-R/A	●	SAE J595	12		
	*LHU-42-R/B	●	SAE J595	8	*LHU-62-R/B	●	SAE J595	12	*LHU-C1-R/B	●	SAE J595	12		
	*LHU-42-R/C	●	SAE J595	8	*LHU-62-R/C	●	SAE J595	12	*LHU-C1-R/C	●	SAE J595	12		
	*LHU-42-B/A	●	SAE J595	8	*LHU-62-B/A	●	SAE J595	12	*LHU-C1-B/A	●	SAE J595	12		
	*LHU-42-B/C	●	SAE J595	8	*LHU-62-B/C	●	SAE J595	12	*LHU-C1-B/C	●	SAE J595	12		
	*LHU-42-A/C	●	SAE J595	8	*LHU-62-A/C	●	SAE J595	12	LHU-C1-A/C	●	SAE J595	12		
	*LHU-42-A/G	●	SAE J595	8	*LHU-62-A/G	●	SAE J595	12	*LHU-C1-A/G	●	SAE J595	12		
	*LHU-42-C/M	●	SAE J595	8	*LHU-62-C/M	●	SAE J595	12	*LHU-C1-C/M	●	SAE J595	12		
	*LHU-42-C/G	●	SAE J595	8	*LHU-62-C/G	●	SAE J595	12	*LHU-C1-C/G	●	SAE J595	12		
	*LHU-42-RA0	●	SAE J595	8	*LHU-62-RA0	●	SAE J595	12	LHU-C1-RA0	●	SAE J595	12		
	*LHU-42-RB0	●	SAE J595	8	*LHU-62-RB0	●	SAE J595	12	LHU-C1-RB0	●	SAE J595	12		
	*LHU-42-RC0	●	SAE J595	8	*LHU-62-RC0	●	SAE J595	12	*LHU-C1-RC0	●	SAE J595	12		
	*LHU-42-BA0	●	SAE J595	8	*LHU-62-BA0	●	SAE J595	12	*LHU-C1-BA0	●	SAE J595	12		
	*LHU-42-BC0	●	SAE J595	8	*LHU-62-BC0	●	SAE J595	12	LHU-C1-BC0	●	SAE J595	12		
	*LHU-42-AC0	●	SAE J595	8	*LHU-62-AC0	●	SAE J595	12	LHU-C1-AC0	●	SAE J595	12		
	*LHU-42-AG0	●	SAE J595	8	*LHU-62-AG0	●	SAE J595	12	*LHU-C1-AG0	●	SAE J595	12		
	*LHU-42-CM0	●	SAE J595	8	*LHU-62-CM0	●	SAE J595	12	*LHU-C1-CM0	●	SAE J595	12		
	*LHU-42-CG0	●	SAE J595	8	*LHU-62-CG0	●	SAE J595	12	*LHU-C1-CG0	●	SAE J595	12		

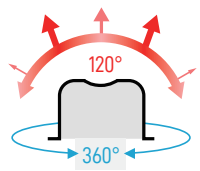

*Production is contingent upon reaching a specified order quantity.

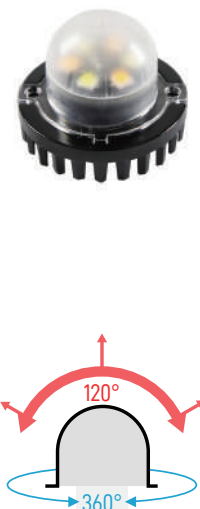
LHR					LHR					LHR				
Optics	Model	LED Color	Compliance	LED	Model	LED Color	Compliance	LED	Model	LED Color	Compliance	LED		
Dome with no optics 	*LHR-41-R00	●	SAE J595	4	LHR-61-R00	●	SAE J595	6	LHR-81-R00	●	SAE J595	8		
	*LHR-41-B00	●	SAE J595	4	LHR-61-B00	●	SAE J595	6	*LHR-81-B00	●	SAE J595	8		
	*LHR-41-A00	●	SAE J595	4	LHR-61-A00	●	SAE J595	6	LHR-81-A00	●	SAE J595	8		
	*LHR-41-C00	●	SAE J595	4	LHR-61-C00	●	SAE J595	6	LHR-81-C00	●	SAE J595	8		
	*LHR-41-G00	●	SAE J595	4	*LHR-61-G00	●	SAE J595	6	*LHR-81-G00	●	SAE J595	8		
	*LHR-41-M00	●	SAE J595	4	*LHR-61-M00	●	SAE J595	6	*LHR-81-M00	●	SAE J595	8		
	*LHR-41-RA0	●	SAE J595	4	*LHR-61-R/A	●	SAE J595	6	*LHR-81-R/A	●	SAE J595	8		
	*LHR-41-RB0	●	SAE J595	4	LHR-61-R/B	●	SAE J595	6	*LHR-81-R/B	●	SAE J595	8		
	*LHR-41-RC0	●	SAE J595	4	LHR-61-R/C	●	SAE J595	6	*LHR-81-R/C	●	SAE J595	8		
	*LHR-41-BA0	●	SAE J595	4	*LHR-61-B/A	●	SAE J595	6	*LHR-81-B/A	●	SAE J595	8		
	*LHR-41-BC0	●	SAE J595	4	LHR-61-B/C	●	SAE J595	6	*LHR-81-B/C	●	SAE J595	8		
	*LHR-41-AC0	●	SAE J595	4	*LHR-61-A/C	●	SAE J595	6	LHR-81-A/C	●	SAE J595	8		
	*LHR-41-AG0	●	SAE J595	4	*LHR-61-A/G	●	SAE J595	6	*LHR-81-A/G	●	SAE J595	8		
	*LHR-41-CM0	●	SAE J595	4	*LHR-61-C/M	●	SAE J595	6	*LHR-81-C/M	●	SAE J595	8		
	*LHR-41-CG0	●	SAE J595	4	*LHR-61-C/G	●	SAE J595	6	*LHR-81-C/G	●	SAE J595	8		
	*LHR-42-R00	●	SAE J595	8	*LHR-62-R00	●	SAE J595	12	*LHR-C1-R00	●	SAE J595	12		
	*LHR-42-B00	●	SAE J595	8	*LHR-62-B00	●	SAE J595	12	*LHR-C1-B00	●	SAE J595	12		
	*LHR-42-A00	●	SAE J595	8	LHR-62-A00	●	SAE J595	12	*LHR-C1-A00	●	SAE J595	12		
	*LHR-42-C00	●	SAE J595	8	*LHR-62-C00	●	SAE J595	12	*LHR-C1-C00	●	SAE J595	12		
	*LHR-42-G00	●	SAE J595	8	*LHR-62-G00	●	SAE J595	12	*LHR-C1-G00	●	SAE J595	12		
	*LHR-42-M00	●	SAE J595	8	*LHR-62-M00	●	SAE J595	12	*LHR-C1-M00	●	SAE J595	12		
	*LHR-42-R/A	●	SAE J595	8	LHR-62-R/A	●	SAE J595	12	*LHR-C1-R/A	●	SAE J595	12		
	*LHR-42-R/B	●	SAE J595	8	LHR-62-R/B	●	SAE J595	12	*LHR-C1-R/B	●	SAE J595	12		
	*LHR-42-R/C	●	SAE J595	8	*LHR-62-R/C	●	SAE J595	12	*LHR-C1-R/C	●	SAE J595	12		
	*LHR-42-B/A	●	SAE J595	8	LHR-62-B/A	●	SAE J595	12	*LHR-C1-B/A	●	SAE J595	12		
	*LHR-42-B/C	●	SAE J595	8	*LHR-62-B/C	●	SAE J595	12	*LHR-C1-B/C	●	SAE J595	12		
	*LHR-42-A/C	●	SAE J595	8	*LHR-62-A/C	●	SAE J595	12	*LHR-C1-A/C	●	SAE J595	12		
	*LHR-42-A/G	●	SAE J595	8	*LHR-62-A/G	●	SAE J595	12	*LHR-C1-A/G	●	SAE J595	12		
	*LHR-42-C/M	●	SAE J595	8	*LHR-62-C/M	●	SAE J595	12	*LHR-C1-C/M	●	SAE J595	12		
	*LHR-42-C/G	●	SAE J595	8	*LHR-62-C/G	●	SAE J595	12	*LHR-C1-C/G	●	SAE J595	12		
	*LHR-42-RA0	●	SAE J595	8	*LHR-62-RA0	●	SAE J595	12	*LHR-C1-RA0	●	SAE J595	12		
	*LHR-42-RB0	●	SAE J595	8	LHR-62-RB0	●	SAE J595	12	LHR-C1-RB0	●	SAE J595	12		
	*LHR-42-RC0	●	SAE J595	8	*LHR-62-RC0	●	SAE J595	12	*LHR-C1-RC0	●	SAE J595	12		
	*LHR-42-BA0	●	SAE J595	8	*LHR-62-BA0	●	SAE J595	12	*LHR-C1-BA0	●	SAE J595	12		
	*LHR-42-BC0	●	SAE J595	8	*LHR-62-BC0	●	SAE J595	12	*LHR-C1-BC0	●	SAE J595	12		
	*LHR-42-AC0	●	SAE J595	8	*LHR-62-AC0	●	SAE J595	12	*LHR-C1-AC0	●	SAE J595	12		
	*LHR-42-AG0	●	SAE J595	8	*LHR-62-AG0	●	SAE J595	12	*LHR-C1-AG0	●	SAE J595	12		
	*LHR-42-CM0	●	SAE J595	8	*LHR-62-CM0	●	SAE J595	12	*LHR-C1-CM0	●	SAE J595	12		
	*LHR-42-CG0	●	SAE J595	8	*LHR-62-CG0	●	SAE J595	12	LHR-C1-CG0	●	SAE J595	12		

*Production is contingent upon reaching a specified order quantity.

BED Beacon Series

FEATURE

- Ingress Protection Ration: IP67 / IP69K
- Available in Single and Dual
- Input Voltage: 10~30VDC
- Input Current: 3.0A max @ 12.8VDC
- Ambient Temperature Range: -30~70°C
- Flash Pattern : 20
- Accessories: EVA Gasket*1, Screws *3
- Mounting Option: Cig Plug / Magnet
- Synchronizable up to 8 lights



DIMENSIONS

H2.39" x W5.63" (60.8 x 143 mm)

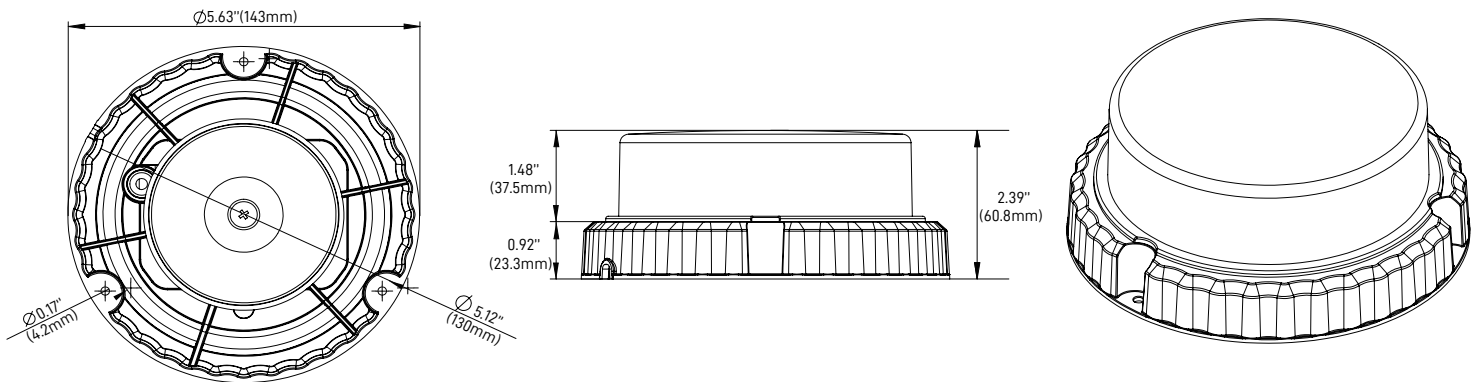

Model	LED Color	Compliance	LED
BED-P1-R00	Red	SAE J845, ECE R10	24
BED-P1-B00	Blue	SAE J845, ECE R10, ECE R65 Class 2	24
BED-P1-A00	Orange	SAE J845, ECE R10, ECE R65 Class 2	24
BED-P1-C00	White	SAE J595, ECE R10	24
BED-P1-R/A	Red/White	SAE J845, ECE R10	24
BED-P1-R/B	Red/Blue	SAE J845, ECE R10	24
BED-P1-R/C	Red/White/Blue	SAE J845, ECE R10	24
BED-P1-B/A	Blue/White	SAE J845, ECE R10, ECE R65 Class 1	24
BED-P1-B/C	Blue/White/Blue	SAE J845, ECE R10, ECE R65 Class 1	24
BED-P1-A/C	Orange/White/Blue	SAE J845, ECE R10, ECE R65 Class 1	24

ACCESSORIES

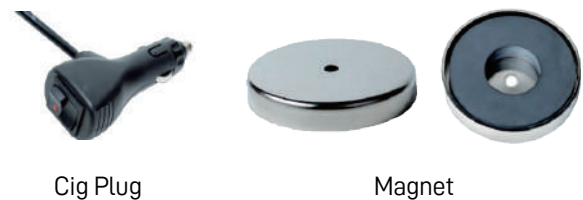

Cig Plug

Magnet

BSD 4" Beacon Series

FEATURE

- Ingress Protection Ration: IP65
- Available in Single
- Input Voltage: 10~30VDC
- Input Current: 2.0 Amps max @12.8VDC
- Ambient Temperature Range: -30~50°C
- Flash Pattern : 30
- Accessories: EVA Gasket*1, Screws *3
- Mounting Option: Cig Plug/ Magnet/Brush Guard
- Synchronizable up to 8 lights



DIMENSIONS

H3.8" x D4.1" (96.33 x 104.2 mm)

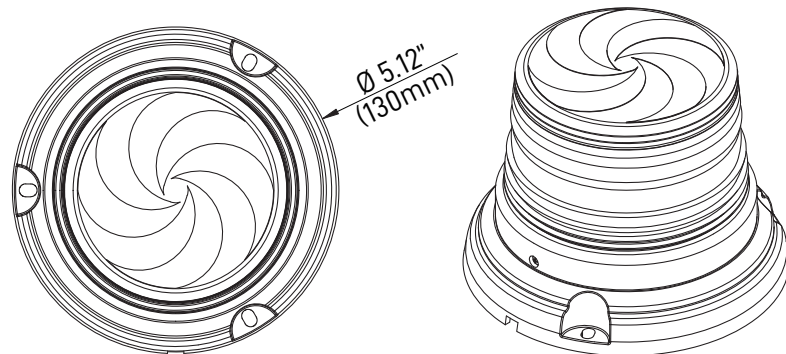
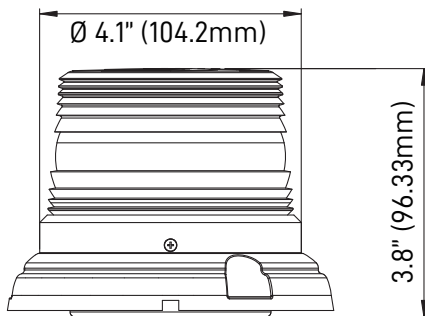

ACCESSORIES

Model	LED Color	Compliance	LED
*BSD-41-R00	Red	SAE J845	4
*BSD-41-B00	Blue	SAE J845	4
BSD-41-A00	Orange	SAE J845	4
*BSD-41-C00	White	SAE J845	4
*BSD-41-G00	Green	SAE J845	4
*BSD-41-M00	Purple	SAE J845	4
BSD-C1-R00	Red	SAE J845	12
BSD-C1-B00	Blue	SAE J845	12
BSD-C1-A00	Orange	SAE J845	12
BSD-C1-C00	White	SAE J845	12
BSD-C1-G00	Green	SAE J845	12
BSD-C1-M00	Purple	SAE J845	12



Cig Plug



Magnet



R02-B-01
Brush Guard

*Production is contingent upon reaching a specified order quantity.

BMD 5" Beacon Series

FEATURE

- Ingress Protection Ration: IP65
- Available in Single
- Input Voltage: 10~30VDC
- Input Current: 2.0 Amps max @12.8VDC
- Ambient Temperature Range: -30~50°C
- Flash Pattern : 30
- Accessories: EVA Gasket*1, Screws *3
- Mounting Option: Cig Plug/ Magnet/Brush Guard
- Synchronizable up to 8 lights



DIMENSIONS

H5.51" x D6.5" (140 x 165 mm)

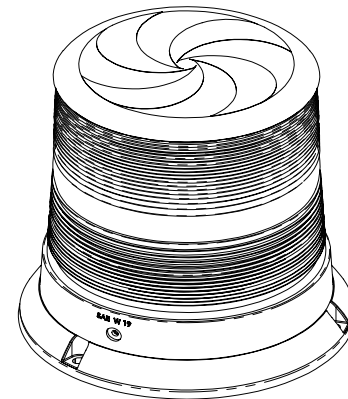
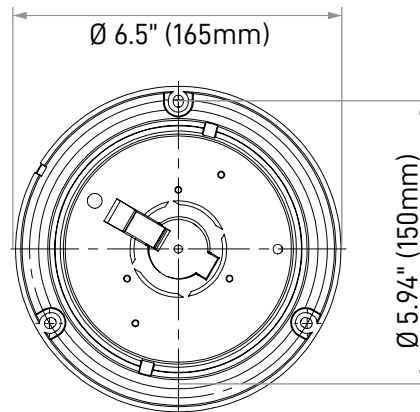
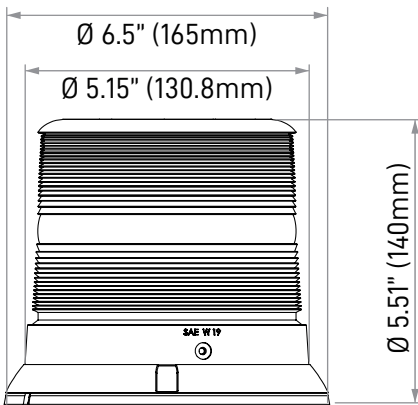

Model	LED Color	Compliance	LED
BMD-C1-R00	●	SAE J845	12
BMD-C1-B00	●	SAE J845	12
BMD-C1-A00	●	SAE J845	12
BMD-C1-C00	●	SAE J845	12
BMD-C1-G00	●	SAE J845	12
BMD-C1-M00	●	SAE J845	12
*BMD-G1-R00	●	SAE J845	16
*BMD-G1-B00	●	SAE J845	16
BMD-G1-A00	●	SAE J845	16
*BMD-G1-C00	●	SAE J845	16
*BMD-G1-G00	●	SAE J845	16
*BMD-G1-M00	●	SAE J845	16

ACCESSORIES



Cig Plug

Magnet

*Production is contingent upon reaching a specified order quantity.

BLD 7" Beacon Series

FEATURE

- Ingress Protection Rating: IP65
- Available in Single
- Input Voltage: 10~30VDC
- Input Current: 2.0 Amps max @12.8VDC
- Ambient Temperature Range: -30~50°C
- Flash Pattern : 30
- Accessories: EVA Gasket*1, Screws *3
- Mounting Option: Cig Plug/ Magnet/Brush Guard
- Synchronizable up to 8 lights



DIMENSIONS

H6.5" x D5.15" (165 x 130.8 mm)

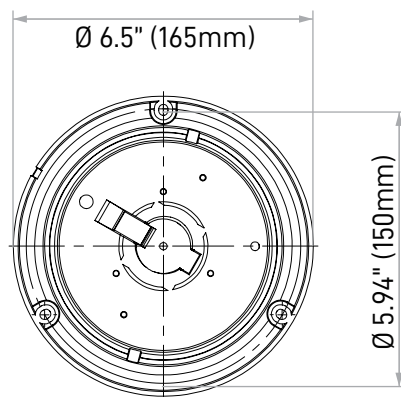
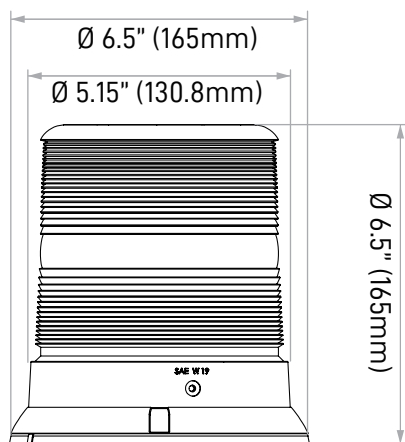

Model	LED Color	Compliance	LED
BLD-C1-R00	Red	SAE J845	12
BLD-C1-B00	Blue	SAE J845	12
BLD-C1-A00	Orange	SAE J845	12
BLD-C1-C00	White	SAE J845	12
BLD-C1-G00	Green	SAE J845	12
BLD-C1-M00	Purple	SAE J845	12
*BLD-G1-R00	Red	SAE J845	16
*BLD-G1-B00	Blue	SAE J845	16
BLD-G1-A00	Orange	SAE J845	16
*BLD-G1-C00	White	SAE J845	16
*BLD-G1-G00	Green	SAE J845	16
*BLD-G1-M00	Purple	SAE J845	16

ACCESSORIES



Cig Plug

Magnet

*Production is contingent upon reaching a specified order quantity.

RLAL *Running Light Series*



FEATURE

- Linear Optics
- Ingress Protection Rating: IP67
- Input Voltage: 10~30VDC
- Input Current:
 - 1 Module: 0.8 Amps Max
 - 2 Module: 1.6 Amps Max
 - 3 Module: 2.4 Amps Max
 - 4 Module: 3.2 Amps Max
 - 5 Module: 4.0 Amps Max
 - 6 Module: 4.8 Amps Max

Single Color Versions: 1/2/3/4/5/6 Modules

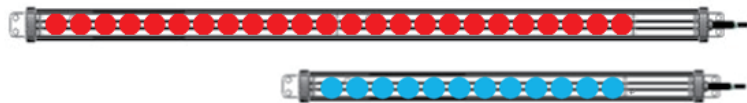

Dual Color Versions: 1/2/3/4/5/6 Modules

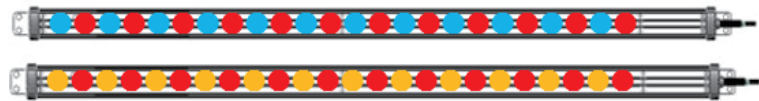

Dual Multicolor Versions: 1/2/3/4/5/6 Modules



DIMENSIONS

1 Module: L15.7" x W0.91" x H0.31" (398.8 x 23 x 8 mm)



2 Module: L27.1" x W0.91" x H0.31" (688.3 x 23 x 8 mm)



3 Module: L38.5" x W0.91" x H0.31" (977.9 x 23 x 8 mm)



4 Module: L50" x W0.91" x H0.31" (1270 x 23 x 8 mm)



5 Module: L61.4" x W0.91" x H0.31" (1559.6 x 23 x 8 mm)



6 Module: L72.8" x W0.91" x H0.31" (1849.1 x 23 x 8 mm)



Colors Modules Quantity	R	B	A	C	R/A	R/B	R/C	B/A	B/C	A/C	A/G	C/G	X01	X02	X03	X04	X05	X06	X07	X08
	C1	●	●	●	●	○	○	●	●	●	●	○	●	●	●	●				
C2	○	●	●	○	●	●	●	●	●	●	○	●	○	○	●	○	○			○
C3	○	●	●	○	○	●	○	●	●	●	○	○	○	○	○					○
C4	○	○	○	○	○	●	●	●	●	●	●	○	●	○	○	●	○			○
C5	○	○	○	○	○	●	●	●	●	●	●	○	●	○	○			○	○	●
C6	○	○	○	○	○	○	○	○	○	○	○	○	○	○	○	●	●			○

○: Production is contingent upon reaching a specified order quantity.

C1: C= 12 LED, 1= 1Module

General specifications

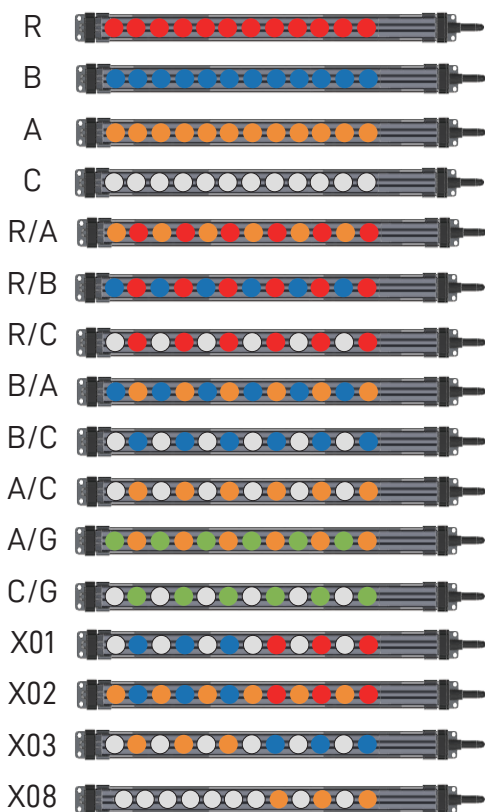

Special specifications

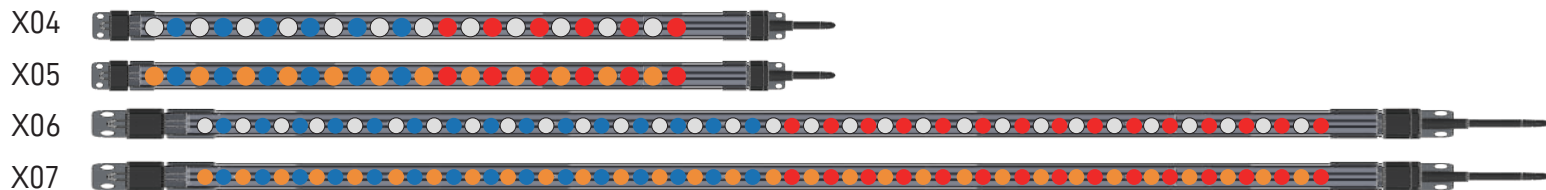

※ X04: Available C2, C4, C6

X05: Available C2, C4, C6

X06: Available C5

X07: Available C5

LIGHTSTICK Series

FEATURE

- Compliance: SAE J595, CA T13
- Ingress Protection Ration: IP67
- Available in Single and Split
- Available in 2 , 4, 6 and 8 Models
- High Power: LED*3, 4, 6, 8 / Per Module
- Input Voltage: 10~30VDC
- Ambient Temperature Range: -30~50°C
- Flash Pattern : 25 (2 modules), 31 (4/6/8 modules)
- Accessories: L bracket/Screw *4,Switch Panel*1 or Control Box*1
- Synchronizable up to 8 lights

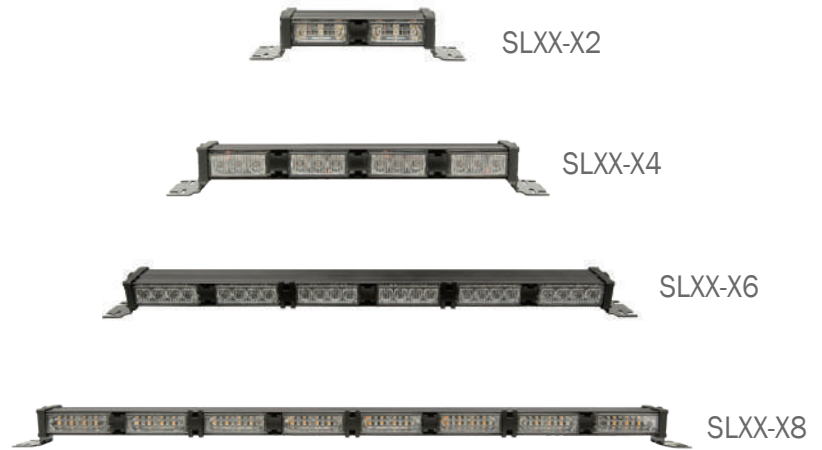

DIMENSIONS

Model	3or6 LED	4 LED
2 Model	7.05" (179mm)	4.57" (116mm)
4 Model	14.45" (367mm)	9.14" (232.1mm)
6 Model	21.77" (553mm)	18.11" (460mm)
8 Model	29.09" (739mm)	26.98" (685.2mm)

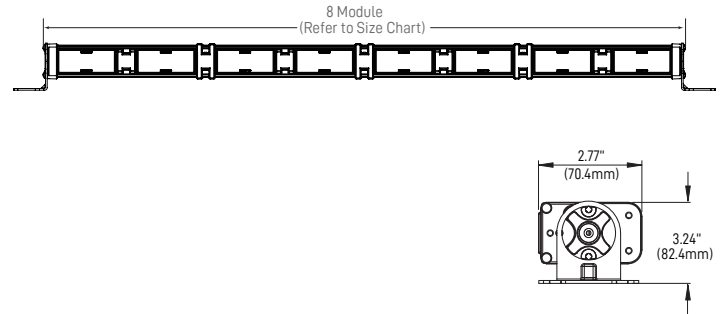

INPUT CURRENT

Model	3or6 LED	4 LED
2 Model	1.0/2.0A max @DC12V	1.6Amps max @DC12V
4 Model	1.6/3.2A max @DC12V	3.2Amps max @DC12V
6 Model	2.4/4.8A max @DC12V	4.8Amps max @DC12V
8 Model	3.2/6.4A max @DC12V	6.4Amps max @DC12V

OPTIONAL ACCESSORIES:

Model	Option Description
R02-L-07	Light Head 2 Inch Bracket Screw Kits
R02-L-08	Light Head 3 Inch Bracket Screw Kits
R04-AA-06	7 Hole On/off/pattern Switch Control Panel (Positive Trigger)
R04-AA-08	Standard 7 Hole Control Box (Positive Trigger)



	R	B	A	C	G	M	RA	RB	RC	BA	BC	AC	AG	CM	CG
3F-32	○	○	●	○	○	○	○	○	○	○	○	○	○	○	○
3F-34	○	○	○	○	○	○	○	○	○	○	○	○	○	○	○
3F-36	○	○	○	○	○	○	○	○	○	○	○	○	○	○	○
3F-38	○	○	○	○	○	○	○	○	○	○	○	○	○	○	○
3E-32	○	○	○	○	○	○	○	○	○	○	○	○	○	○	○
3E-34	○	○	○	○	○	○	○	○	○	○	○	○	○	○	○
3E-36	○	○	●	○	○	○	○	○	○	○	○	○	○	○	○
3E-38	○	○	○	○	○	○	○	●	○	○	○	○	○	○	○
3C-32	○	○	○	○	○	○	○	○	○	○	○	○	○	○	○
3C-34	○	○	○	○	○	○	○	○	○	○	○	○	○	○	○
3C-36	○	○	○	○	○	○	○	○	○	○	○	○	○	○	○
3C-38	○	○	○	○	○	○	○	○	○	○	○	○	○	○	○
3L-32	○	○	○	○	○	○	○	○	○	○	○	○	○	○	○
3L-34	○	○	○	○	○	○	○	○	○	○	○	○	○	○	○
3L-36	○	○	○	○	○	○	○	○	○	○	○	○	○	○	○
3L-38	○	○	○	○	○	○	○	○	○	○	○	○	○	○	○
3S-32	○	○	○	○	○	○	○	○	○	○	○	○	○	○	○
3S-34	○	○	○	○	○	○	○	○	○	○	○	○	○	○	○
3S-36	○	○	○	○	○	○	○	○	○	○	○	○	○	○	○
3S-38	○	○	○	○	○	○	○	○	○	○	○	○	○	○	○
3R-32	○	○	○	○	○	○	○	○	○	○	○	○	○	○	○
3R-34	○	○	○	○	○	○	○	●	○	○	○	○	○	○	○
3R-36	○	○	○	○	○	○	○	●	○	○	○	○	○	○	○
3R-38	○	○	○	○	○	○	○	●	○	○	○	○	○	○	○

○: Production is contingent upon reaching a specified order quantity.

LIGHT BAR Series

FEATURE

- Ingress Protection Rating: IP65
- Available in Single
- Available in 37" , 47" and 57" lengths
- Input Voltage: 10~15VDC
- Input Current: 20A max@DC12V
- Ambient Temperature Range: -40~70°C
- Flash Pattern: 31
- Housing: Polycarbonate
- Top Cover / Bottom Cover : Plastic
- Mounting Options: Metal bracket or Plastic bracket

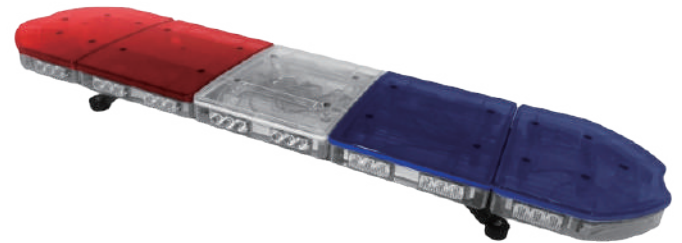

DIMENSIONS

L47" x W11.47" x H3.04" (1195.5 x 291.5 x 77.3 mm)

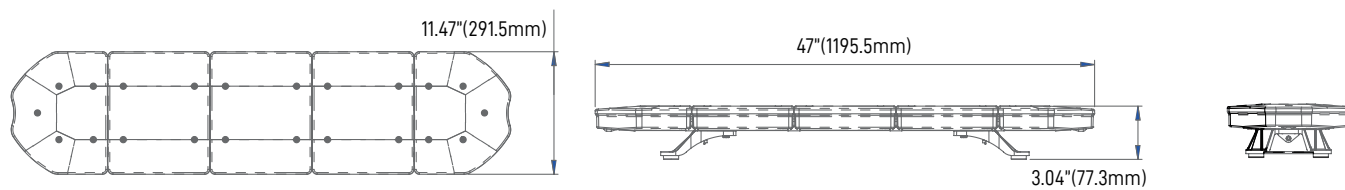

Model	LED Color	Compliance
JJE47-S-R/B		Meet ECE R65 Class 1
JJE47-S-R00		Meet ECE R65 Class 1 , SAE J845
JJE47-S-B00		Meet ECE R65 Class 1 , SAE J845
JJE47-S-A00		Meet ECE R65 Class 1 , SAE J845
JJE67-S-A00		Meet ECE R65 Class 1

ACCESSORIES



CB-12

MINI BAR MC Series

FEATURE

- Optics: E Optics (Focus+Diffuser), L Optics on the side
- Ingress Protection Rating: IP67
- Available in Single and Split
- High power : 3 LED * 8 Module
- Input Voltage: 10~30V
- Input Current: 7.0A max. @DC12V, 4.0A max. @DC24V
- Ambient Temperature Range: -30~50°C
- Flash Pattern: 60
- Mounting Options: Permanent or Magnet



DIMENSIONS

L11.4" x W7.62" x H2.25" (289.6 x 193.6 x 57.1 mm)

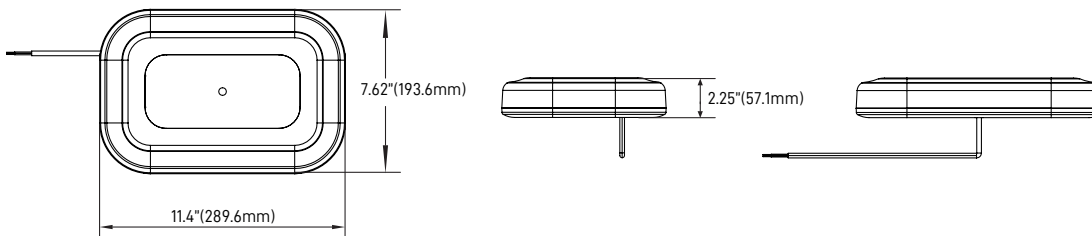

ACCESSORIES



Cig Plug

Magnet

Model	LED Color	LED	Compliance
MCE-38-R00	●	24	SAE J845, ECE R10, SAE J845,
MCE-38-B00	●	24	SAE J845, ECE R65 Class 2, ECE R10
MCE-38-A00	●	24	SAE J845, ECE R65 Class 2, ECE R10
MCE-38-G00	●	24	SAE J845, ECE R10
MCE-38-RB0	●	24	SAE J845, ECE R10
MCE-38-RC0	●	24	SAE J845, ECE R10
MCE-38-AC0	●	24	SAE J845, ECE R10
MCE-38-GC0	●	24	SAE J845, ECE R10
MCL-38-R00	●	24	SAE J845, ECE R65 Class 2, ECE R10
MCL-38-B00	●	24	SAE J845, ECE R65 Class 2, ECE R10
MCL-38-A00	●	24	SAE J845, ECE R10
MCL-38-G00	●	24	SAE J845, ECE R10
MCL-38-M00	●	24	SAE J845, ECE R10
MCL-38-RA0	●	24	SAE J845, ECE R10
MCL-38-RB0	●	24	SAE J845, ECE R10
MCL-38-RC0	●	24	SAE J845, ECE R10
MCL-38-BA0	●	24	SAE J845, ECE R10
MCL-38-BC0	●	24	SAE J845, ECE R10
MCL-38-AC0	●	24	SAE J845, ECE R10
MCL-38-MC0	●	24	SAE J845, ECE R10
MCL-38-GC0	●	24	SAE J845, ECE R10

MINI BAR *MC Series*

FEATURE

- Optics: E Optics (Focus+Diffuser), L Optics on the side
- Compliance: ECE R65 II (B, A), ECE R10, SAE J845
- Ingress Protection Rating: IP67
- Available in Single
- High power : 6 LED * 4 Module
- Input Voltage: 10~30V
- Input Current: 7.0A max. @DC12V, 5.0A max. @DC24V
- Ambient Temperature Range: -30~50°C
- Flash Pattern: 29
- Mounting Options: Permanent or Magnet



DIMENSIONS

L11.4" x W7.62" x H2.25" (289.6 x 193.6 x 57.1 mm)

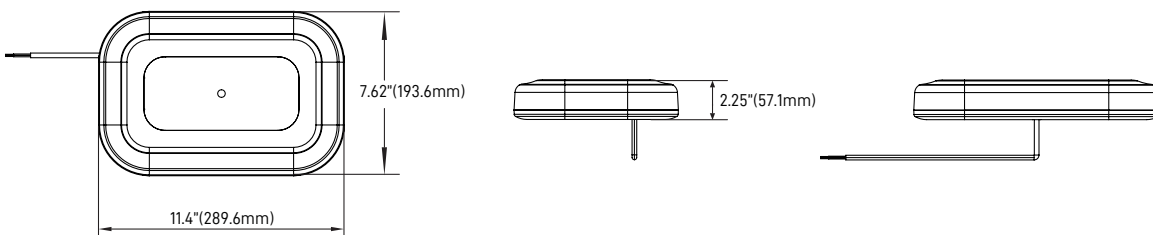

Model	LED Color	LED	Compliance
MCL-64-R00	●	24	SAE J845, ECE R10
*MCL-64-B00	●	24	SAE J845, ECE R10
MCL-64-A00	●	24	SAE J845, ECE R10
*MCL-64-C00	●	24	SAE J845, ECE R10
*MCL-64-G00	●	24	SAE J845, ECE R10
*MCL-64-MB0	●	24	SAE J845, ECE R10

ACCESSORIES



Cig Plug



Magnet

*Production is contingent upon reaching a specified order quantity.

MINI BAR *MB Series*

FEATURE

- Optics: E Optics (Focus+Diffuser), L Optics on the side
- Ingress Protection Ration: IP65
- Available in Single and Split
- High power : 4 LED * 10 Module
- Input Voltage: 12 ~ 24 VDC
- Input Current: 7.0A max. @DC12V, 5.0A max. @DC24V
- Ambient Temperature Range: -40~60°C
- Flash Pattern: 60
- Mounting Options: Permanent or Magnet



DIMENSIONS

L16.44" x W9.45" x H2.45" (417.6 x 240 x 62.2 mm)

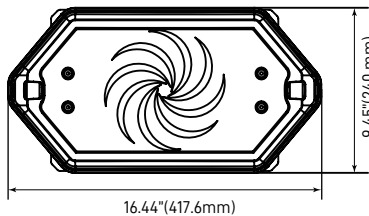

Model	LED Color	LED	Compliance
MBE-4A-R00		40	SAE J845
MBE-4A-B00		40	SAE J845
MBE-4A-A00		40	SAE J845
MBE-4A-M00		40	SAE J845
MBE-4A-RB0		40	SAE J845
MBE-4A-BA0		40	SAE J845
MBE-4A-BC0		40	SAE J845

ACCESSORIES



Cig Plug



Magnet

MINI INNER BAR *JIMS1 Series*

FEATURE

- Available in Dual and Tri Color
- High power : 6 or 9 LED * 8Module
- Input Voltage: 10~30V
- Input Current: 8.0A max@DC12V, 5.0A max@DC24V
- Ambient Temperature Range: -30~50°C
- Flash Pattern: Dual 52, Tri 57
- Mounting Options: Universal standard version



DIMENSIONS

L51.42" x W4.72" x H0.76" (1306.1 x 120 x 19.2 mm)

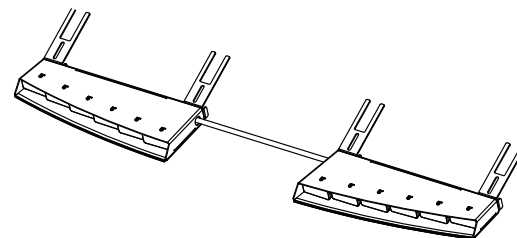
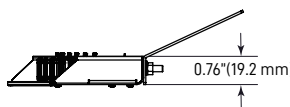
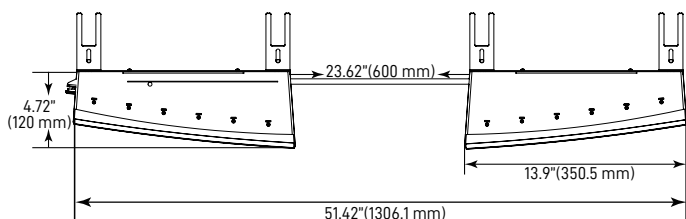

Model	LED Color	LED	Compliance
JIMS1-68-R/A		48	Meet SAE J595, Meet ECE R10
JIMS1-68-R/B		48	Meet SAE J595, Meet ECE R10
JIMS1-68-R/C		48	Meet SAE J595, Meet ECE R10
JIMS1-68-B/A		48	Meet SAE J595, Meet ECE R10
JIMS1-68-A/C		48	Meet SAE J595, Meet ECE R10
JIMS1-98-BAC		56	Meet SAE J595, Meet ECE R10
JIMS1-98-MGC		56	Meet SAE J595, Meet ECE R10
JIMS1-98-RAC		56	Meet SAE J595, Meet ECE R10
JIMS1-98-RBA		56	Meet SAE J595, Meet ECE R10
JIMS1-98-RBC		56	Meet SAE J595, Meet ECE R10

ACCESSORIES



CB-12



Universal Mount

U SHAPE Series

FEATURE

- Ingress Protection Rating: IP67, IP69
- Available in Single and Dual
- Available in 4 Models
- High Power: Single LED*6, Dual *12
- Input Voltage: 10-30 VDC @ 5 A Fuse
- Input Current: 4 Amp Max
- Ambient Temperature Range: -30~70°C
- Flash Pattern : 34 (Single), 61 (Dual)
- Accessories: L bracket *1 , Screws*2
- Synchronizable up to 8 lights



DIMENSIONS

L13.78" x W1.32" x H6.5" (350.1 x 33.6 x 165.1 mm)

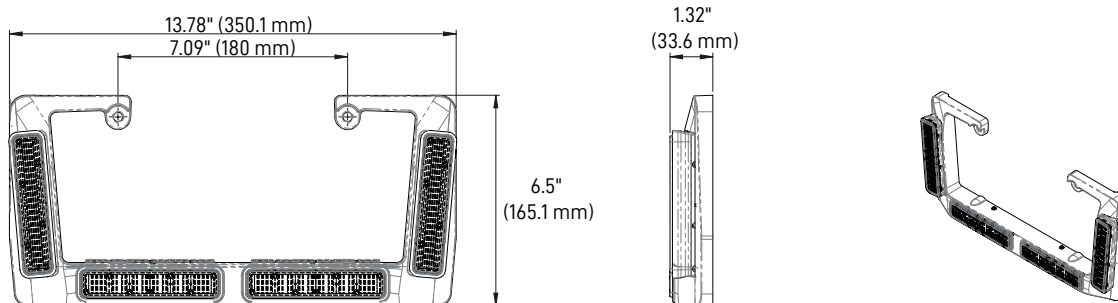

Model	LED Color	LED	Compliance
JOCU1-D5-A/C		48	SAE J595, CA T13, ECE R10
JOCU1-D5-B/C		48	SAE J595, CA T13, ECE R10
JOCU1-D5-R/B		48	SAE J595, CA T13, ECE R10
JOCU1-D5-R/C		48	SAE J595, CA T13, ECE R10
JOCU1-S6-B00		24	SAE J595, CA T13, ECE R10

DASH Series

FEATURE

- Compliance: SAE J595, ECE R10
- Ingress Protection Rating: IP65
- Available in Single and Split
- Available in 1 and 2 Models
- High Power: LED*4, 6, 8, 12
- Input Voltage: 10~30VDC
- Ambient Temperature Range: -30~50°C
- Accessories: Suction cups / Adhesive foam / Universal Swivel U Bracket / Screws
- Mounting Option: Permanent mount / Suction mount



INPUT CURRENT

Model-LED/Module	Amps Max
1 Model-41/61/81	0.9 Amps Max
2 Model-42/62/82	1.5 Amps Max
1 Model-61/C1	2.0 Amps Max

FLASH PATTERN

Model-LED/Module	Pattern
1 Model-41/61/81	25
2 Model-42/62/82	37
1 Model-61/C1	40

DIMENSIONS

L10' x W5.22" x H2.74" (255.5 x 132.5 x 69.6 mm)

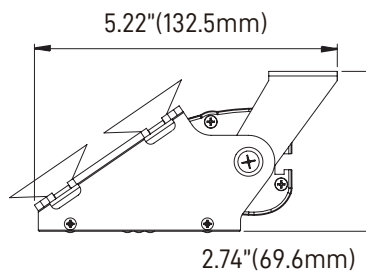
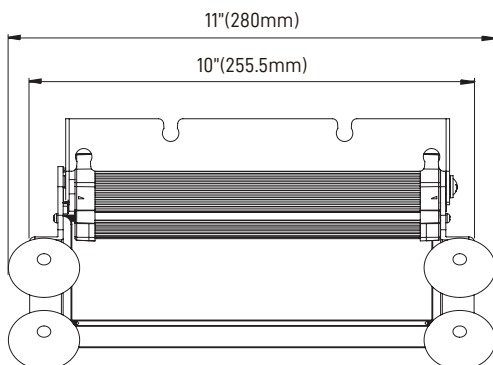

ACCESSORIES:



Model	LED Color	LED	Compliance
WW4C-41-R00	●	4	SAE J595, ECE R10
WW4C-41-B00	●	4	SAE J595, ECE R10
WW4C-41-A00	●	4	SAE J595, ECE R10
WW4C-41-C00	○	4	SAE J595, ECE R10
WW4C-41-G00	●	4	SAE J595, ECE R10
WW4C-41-M00	●	4	SAE J595, ECE R10
WW4C-41-AC0	○	4	SAE J595, ECE R10
WW4C-41-RB0	●	4	SAE J595, ECE R10
WW4C-42-R00	●	8	SAE J595, ECE R10
WW4C-42-B00	●	8	SAE J595, ECE R10
WW4C-42-A00	●	8	SAE J595, ECE R10
WW4C-42-C00	○	8	SAE J595, ECE R10
WW4C-42-G00	●	8	SAE J595, ECE R10
WW4C-42-M00	●	8	SAE J595, ECE R10
WW4C-42-RA0	●	8	SAE J595, ECE R10
WW4C-42-RB0	●	8	SAE J595, ECE R10
WW4C-42-RC0	○	8	SAE J595, ECE R10
WW4C-42-BA0	●	8	SAE J595, ECE R10
WW4C-42-BC0	○	8	SAE J595, ECE R10
WW4C-42-AC0	○	8	SAE J595, ECE R10
WW4L-41-B00	●	4	SAE J595, ECE R10
WW4L-41-G00	●	4	SAE J595, ECE R10
WW4L-41-RB0	●	4	SAE J595, ECE R10
WW4L-42-G00	●	8	SAE J595, ECE R10
WW4L-42-RB0	●	8	SAE J595, ECE R10
WW4L-61-R00	●	6	SAE J595, ECE R10
WW4L-61-B00	●	6	SAE J595, ECE R10
WW4L-61-A00	●	6	SAE J595, ECE R10
WW4L-61-C00	○	6	SAE J595, ECE R10
WW4L-61-G00	●	6	SAE J595, ECE R10
WW4L-61-M00	●	6	SAE J595, ECE R10
WW4L-62-R00	●	12	SAE J595, ECE R10
WW4L-62-B00	●	12	SAE J595, ECE R10
WW4L-62-A00	●	12	SAE J595, ECE R10
WW4L-62-C00	○	12	SAE J595, ECE R10
WW4L-62-G00	●	12	SAE J595, ECE R10
WW4L-62-A/C	○	12	SAE J595, ECE R10
WW4L-62-RB0	●	12	SAE J595, ECE R10
WW4L-81-B00	●	8	SAE J595, ECE R10
WW4L-81-A00	●	8	SAE J595, ECE R10
WW4L-81-R/B	●	8	SAE J595, ECE R10
WW4L-81-B/A	●	8	SAE J595, ECE R10
WW4L-82-R00	●	16	SAE J595, ECE R10
WW4L-82-B00	●	16	SAE J595, ECE R10
WW4L-82-A00	●	16	SAE J595, ECE R10
WW4L-82-C00	○	16	SAE J595, ECE R10
WW4L-82-G00	●	16	SAE J595, ECE R10
WW4L-82-M00	●	16	SAE J595, ECE R10

Model	LED Color	LED	Compliance
WW4L-82-RA0	●	16	SAE J595, ECE R10
WW4L-82-RB0	●	16	SAE J595, ECE R10
WW4L-82-RC0	○	16	SAE J595, ECE R10
WW4L-82-BA0	●	16	SAE J595, ECE R10
WW4L-82-BC0	○	16	SAE J595, ECE R10
WW4L-82-AC0	○	16	SAE J595, ECE R10
WW4L-82-AG0	●	16	SAE J595, ECE R10
WW4L-82-CG0	○	16	SAE J595, ECE R10
WW4R-62-R00	●	12	SAE J595, ECE R10
WW4R-62-B00	●	12	SAE J595, ECE R10
WW4R-62-A00	●	12	SAE J595, ECE R10
WW4R-62-C00	○	12	SAE J595, ECE R10
WW4R-62-G00	●	12	SAE J595, ECE R10
WW4R-62-M00	●	12	SAE J595, ECE R10
WW4R-62-RB0	●	12	SAE J595, ECE R10
WW4R-62-RC0	○	12	SAE J595, ECE R10
WW4R-62-BC0	○	12	SAE J595, ECE R10
WW4R-62-AC0	○	12	SAE J595, ECE R10
WW4R-62-CG0	○	12	SAE J595, ECE R10
WW4R-62-R/C	○	12	SAE J595, ECE R10
WW4R-62-B/C	○	12	SAE J595, ECE R10
WW4R-62-A/C	○	12	SAE J595, ECE R10
WW4R-62-C/G	○	12	SAE J595, ECE R10
WW4R-81-M00	●	8	SAE J595, ECE R10
WW4R-81-BC0	○	8	SAE J595, ECE R10
WW4S-41-A00	●	4	SAE J595, ECE R10
WW4S-61-R00	●	6	SAE J595, ECE R10
WW4S-61-B00	●	6	SAE J595, ECE R10
WW4S-61-A00	●	6	SAE J595, ECE R10
WW4S-61-C00	○	6	SAE J595, ECE R10
WW4S-61-G00	●	6	SAE J595, ECE R10
WW4S-61-M00	●	6	SAE J595, ECE R10
WW4S-61-RB0	●	6	SAE J595, ECE R10
WW4S-62-R00	●	12	SAE J595, ECE R10
WW4S-62-B00	●	12	SAE J595, ECE R10
WW4S-62-A00	●	12	SAE J595, ECE R10
WW4S-62-C00	○	12	SAE J595, ECE R10
WW4S-62-G00	●	12	SAE J595, ECE R10
WW4S-62-M00	●	12	SAE J595, ECE R10
WW4S-62-RA0	●	12	SAE J595, ECE R10
WW4S-62-RB0	●	12	SAE J595, ECE R10
WW4S-62-RC0	○	12	SAE J595, ECE R10
WW4S-62-BA0	●	12	SAE J595, ECE R10
WW4S-62-BC0	○	12	SAE J595, ECE R10
WW4S-62-AC0	○	12	SAE J595, ECE R10
WW4S-62-CM0	○	12	SAE J595, ECE R10
WW4S-62-CG0	○	12	SAE J595, ECE R10
WW4S-81-R/A	●	8	SAE J595, ECE R10
WW4S-81-B/A	●	8	SAE J595, ECE R10



TOP WARNING LIGHT TECHNOLOGY CO., LTD.

<https://topwarninglight.com>

EMAIL: twl_sales@topwarninglight.com

TEL: +886 6 203 2910 FAX: +886 6 2532177